

GR-1600XL

160 US TON MAX. CRANE CAPACITY

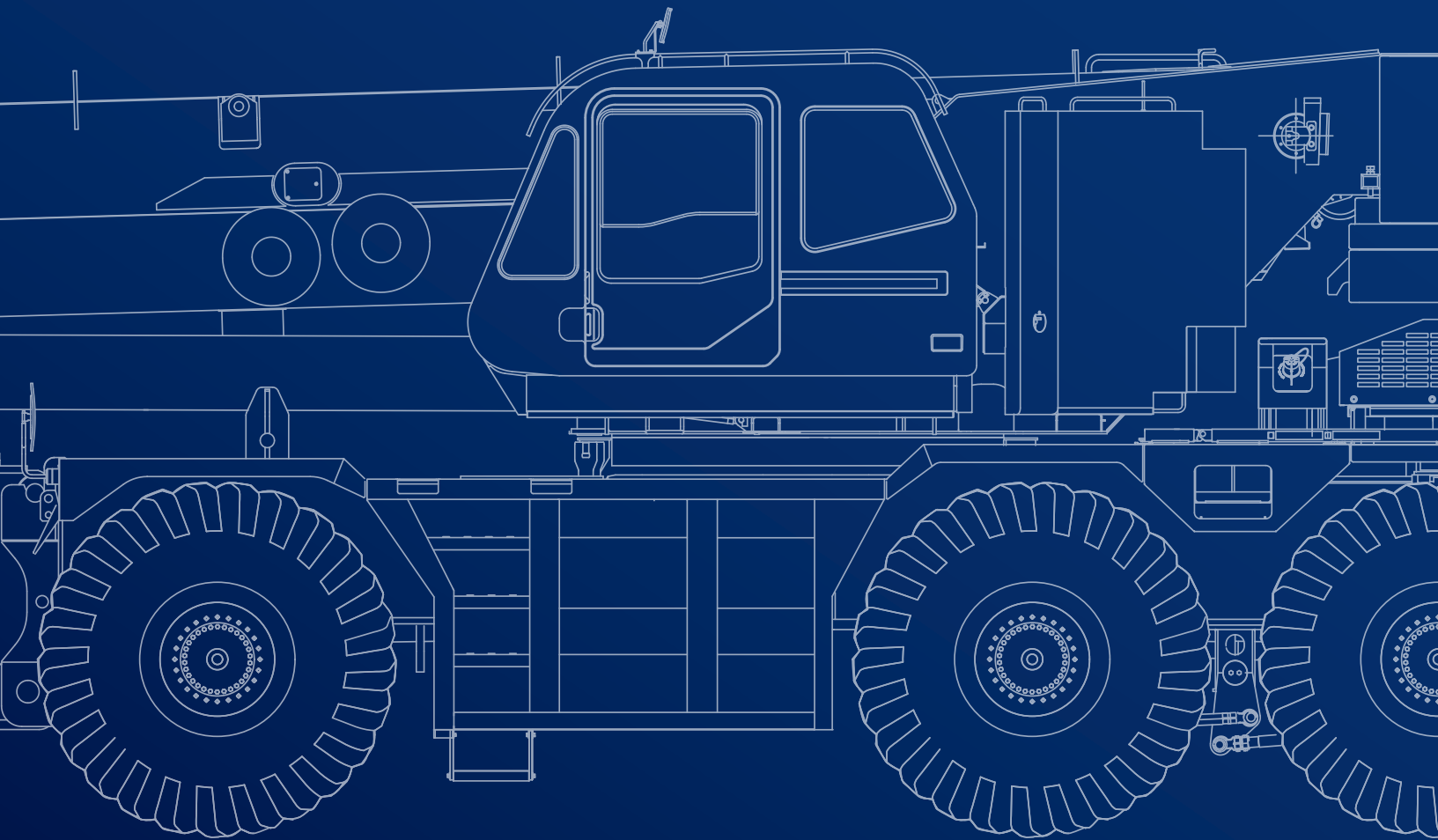

February 2023. Unless otherwise specified, all information in this brochure refers to a standard crane equipment, and it is intended as general information only. No liability is assumed. Errors reserved. Product specifications and prices are subject to changes without notice. The photographs and/or drawings in this brochure are for illustrative purposes only. For correct and safe crane operation, the original operating manual and lifting capacity charts are essential. Failure to follow the corresponding Operator's Manual when using our equipment or failure to otherwise act responsibly may result in property damage, serious injury or death. The sole warranty applicable with respect to our equipment is the standard warranty as per general terms and conditions of sales and service (ask your local Tadano dealer for details), and Tadano makes no other warranty, express or implied. All rights reserved. Any use of the trademarks, logos, brand names and model names used herein is prohibited.

© Tadano Ltd. 2023

Contents

Specifications	5
Vehicle dimensions	6-7
General dimensions	7
Off-road driving	9
Axle weight distribution chart	10
Speeds and gradeability	10
Operation	11
Main boom	12
Slewing	12
Hoist	12
Line speeds and pulls	13
Drum wire rope capacities	13
Drum dimensions	13
MB: Main boom.....	14-16
FJ: Folding swing-away jib.....	18-31
Notes to Lifting Capacity	32-33
Warning and Operating Instructions for on Rubber Lifting Capacities	33
Notes for Load Moment Indicator (AML-C)	34
Technical Description	35
Crane specifications	36-37
Carrier specifications	37
Standard equipment	38-39
Optional equipment	39

Key

	Counterweight		Rope length
	Lifting capacities on outriggers · 360°		Hook block
	Radius		Number of lines
	Main boom		Number of sheaves in hook block
	Main boom length		Line pulls available
	Folding swing-away jib		Possible load of hook block
	Insert		Weight of hook block
	Free on wheels		Distance head sheave axle – hook ground
	Tires		Max. outrigger load
	Hook block		Length of stroke (support cylinders)
	Hoist		Base machine
	Travel speed		Gross vehicle weight
	Gradeability		Weight on 1st axle
	Working speeds		Weight on 2nd axle
	Rope		Weight on 3rd axle
	Boom telescoping		Wire rope layer
	Boom elevation		Total wire rope
	Slewing		Smart Chart: Smart crane control system for main boom and rooster sheave operation enabling higher lifting capacities especially over outriggers. Enables safe use of the full capacity of the crane even in asymmetric outrigger configurations. Visualization of full working area in operator cabin. In-cab lift simulation.
	Max. line pull		
	Rope diameter		

SPECIFICATIONS

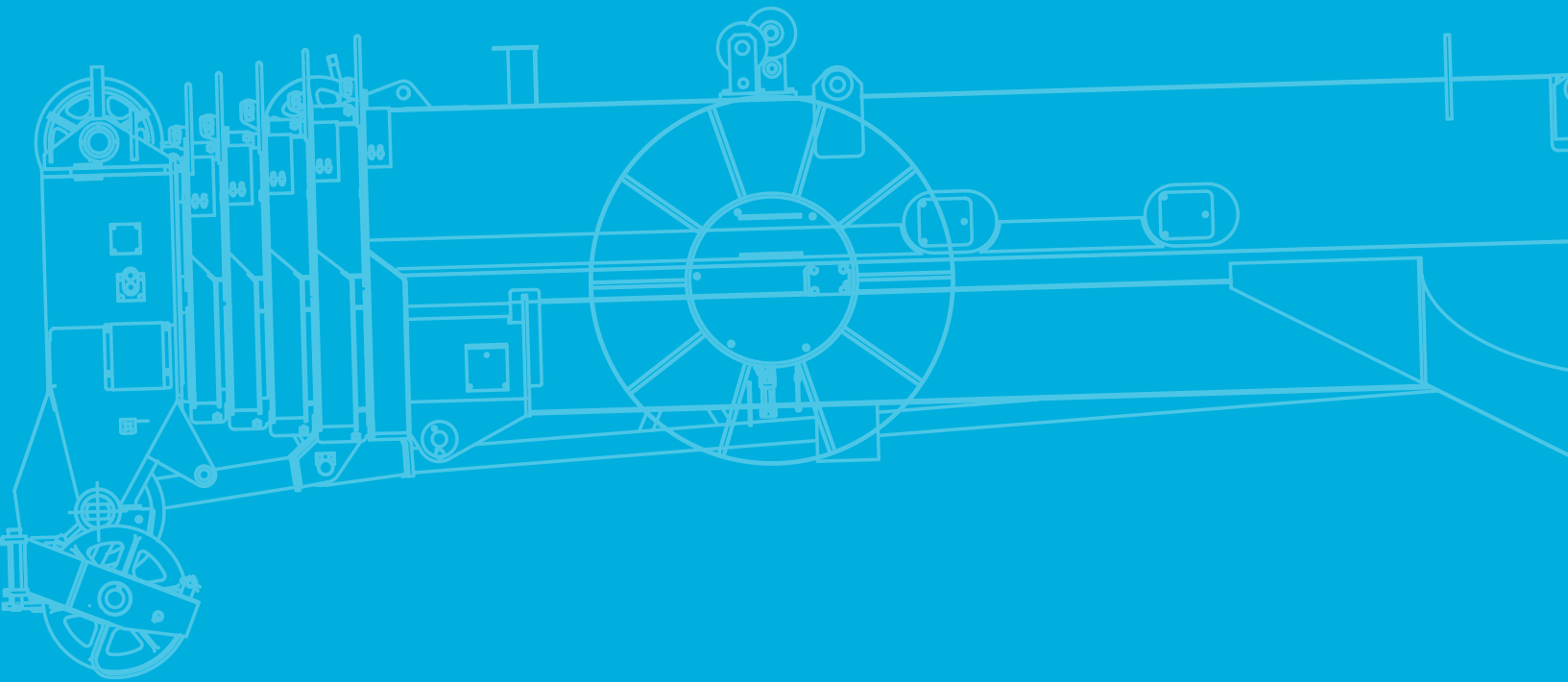

Specifications

Vehicle dimensions

Optional weight 24,500 lb

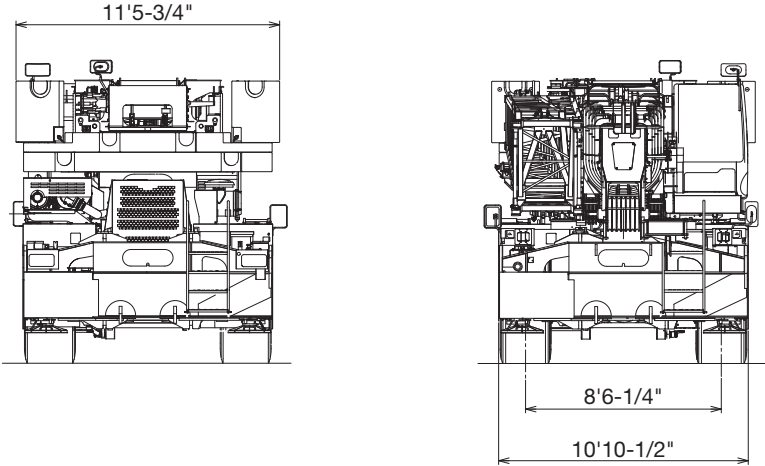

General dimensions





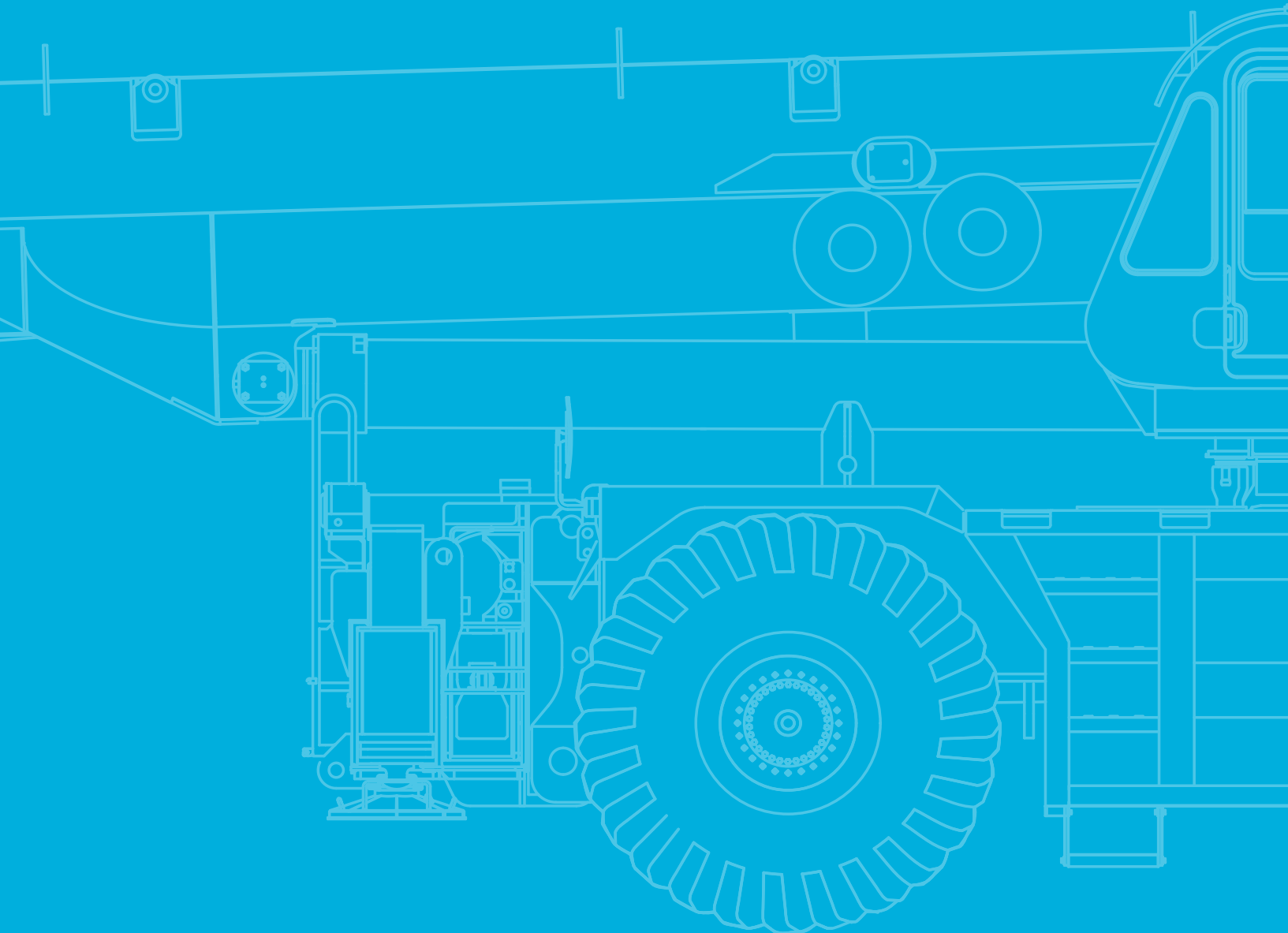

Overall length	approx. 53' 1-3/8"
Overall width	approx. 10' 10-1/2"
Overall height	approx. 12' 5"
Carrier length for traveling	approx. 27' 1-1/4"
6 wheel steer*	32' 6"
2 wheel steer*	48' 11"

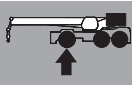
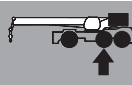

* Turning radius (26.5R25☆☆ tires)

TECHNICAL DATA FOR OFF-ROAD DRIVING



Off-road driving

Axle weight distribution chart				
				
Manual offset jib 	200,960 lb	64,812 lb	67,550 lb	68,599 lb
Remove:  7.9 ton  110 ton  Counterweight 24,500 lb  Counterweight 40,100 lb Front and rear outrigger boxes and beams Auxiliary winch and wire rope Boom and jib	-661 lb	-928 lb	134 lb	134 lb
	-2,381 lb	-3,904 lb	763 lb	763 lb
	-24,515 lb	7,388 lb	-15,953 lb	-15,953 lb
	-40,036 lb	12,066 lb	-26,050 lb	-26,050 lb
	-19,758 lb	-7,635 lb	-6,063 lb	-6,063 lb
	-2,650 lb	1,080 lb	-1,865 lb	-1,865 lb
	-38,413 lb	-49,699 lb	5,642 lb	5,642 lb

Speeds and gradeability	
	26.5 R25
	44% (with counterweight 64,600 lb) 52% (with counterweight 40,100 lb) 57 % Machine should be operated within the limit of engine crankcase design (30°: Cummins QSB6.7 EPA Tier4 Final)
	9.3 mph (with counterweight) 2.5 mph (without counterweight)



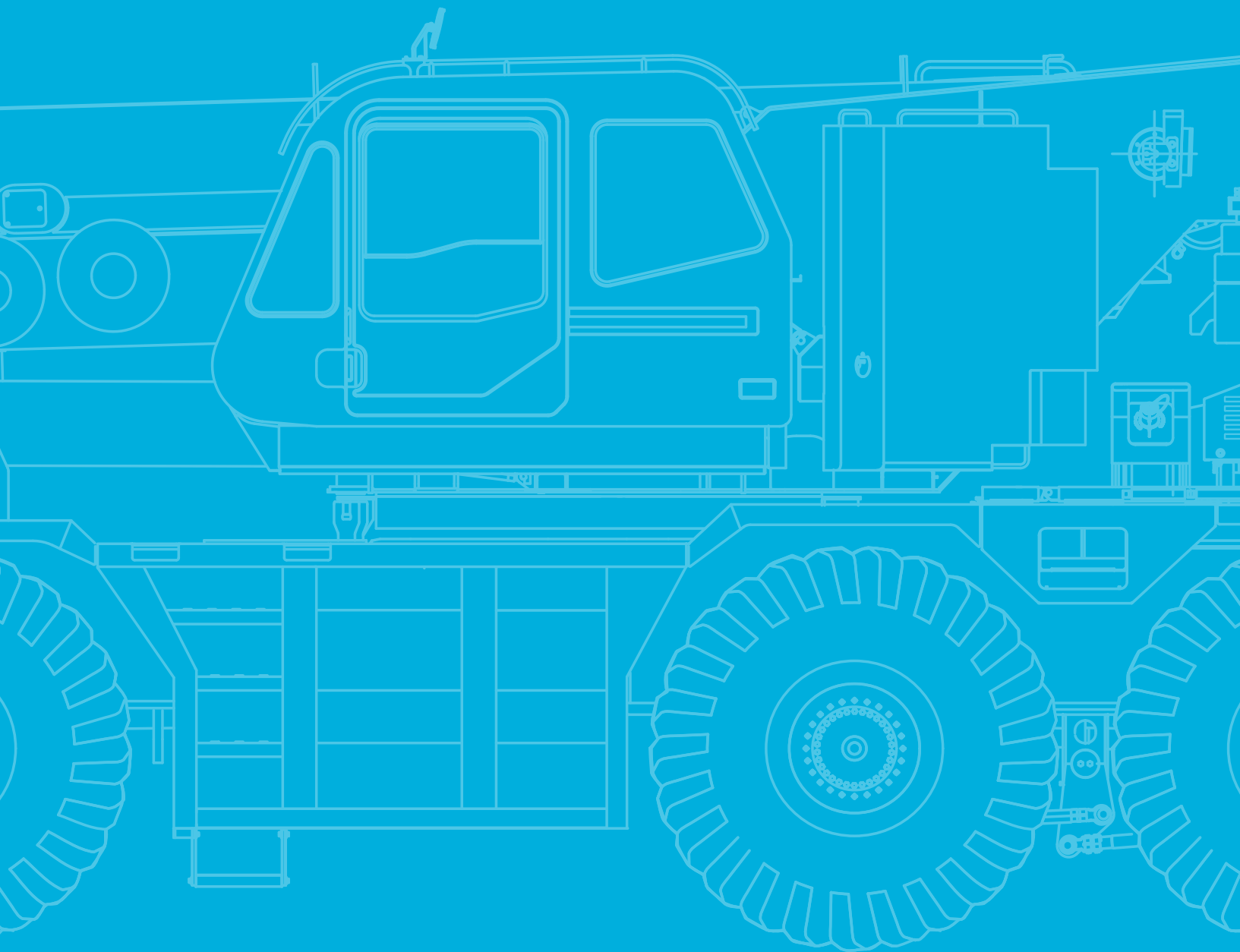

TECHNICAL DATA FOR OPERATION



Operation

Main boom			
	approx. 450 s (42.8 ft - 200.1 ft)		-1.5° - 81.5° approx. 28 s (20° - 60°)





Slewing	
	1.3 min ⁻¹

Hoist			
			
	15,900 lb	3/4"	1050'
	15,900 lb	3/4"	738'

Operation

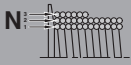
Line speeds and pulls

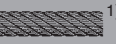
Main or auxiliary winch - 15" drum

 N	  low high		 low
1	253 ft/min.	354 ft/min.	21,800 lb
2	276 ft/min.	384 ft/min.	19,900 lb
3	299 ft/min.	413 ft/min.	18,200 lb
4	318 ft/min.	446 ft/min.	16,800 lb
5	341 ft/min.	476 ft/min.	15,600 lb
6	361 ft/min.	505 ft/min.	14,600 lb
7 ³⁾	384 ft/min.	535 ft/min.	13,700 lb

Maximum permissible line pull wire strength. 15,900 lb with 7 x 35 class rope.



1) Line speed based only on hook block, not loaded.

2) Developed by machinery with each layer of wire rope, but not based on rope strength or other limitations in machinery or equipment.

3) Seventh layer of wire rope are not recommended for hoisting operations.

Drum wire rope capacities

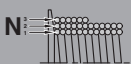
Main and auxiliary drum grooved lagging 3/4" wire rope

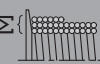
 N		 Σ
1	147.0 ft	147.0 ft
2	159.4 ft	306.4 ft
3	172.2 ft	478.7 ft
4	184.7 ft	663.4 ft
5	197.2 ft	860.6 ft
6	209.6 ft	1070.2 ft
7	222.1 ft	1292.3 ft

Drum dimensions

Root diameter	15"
Length	29-1/4"
Flange diameter	26-5/8"

Operation



Hydraulic offset jib – Counterweight 64,600 lb

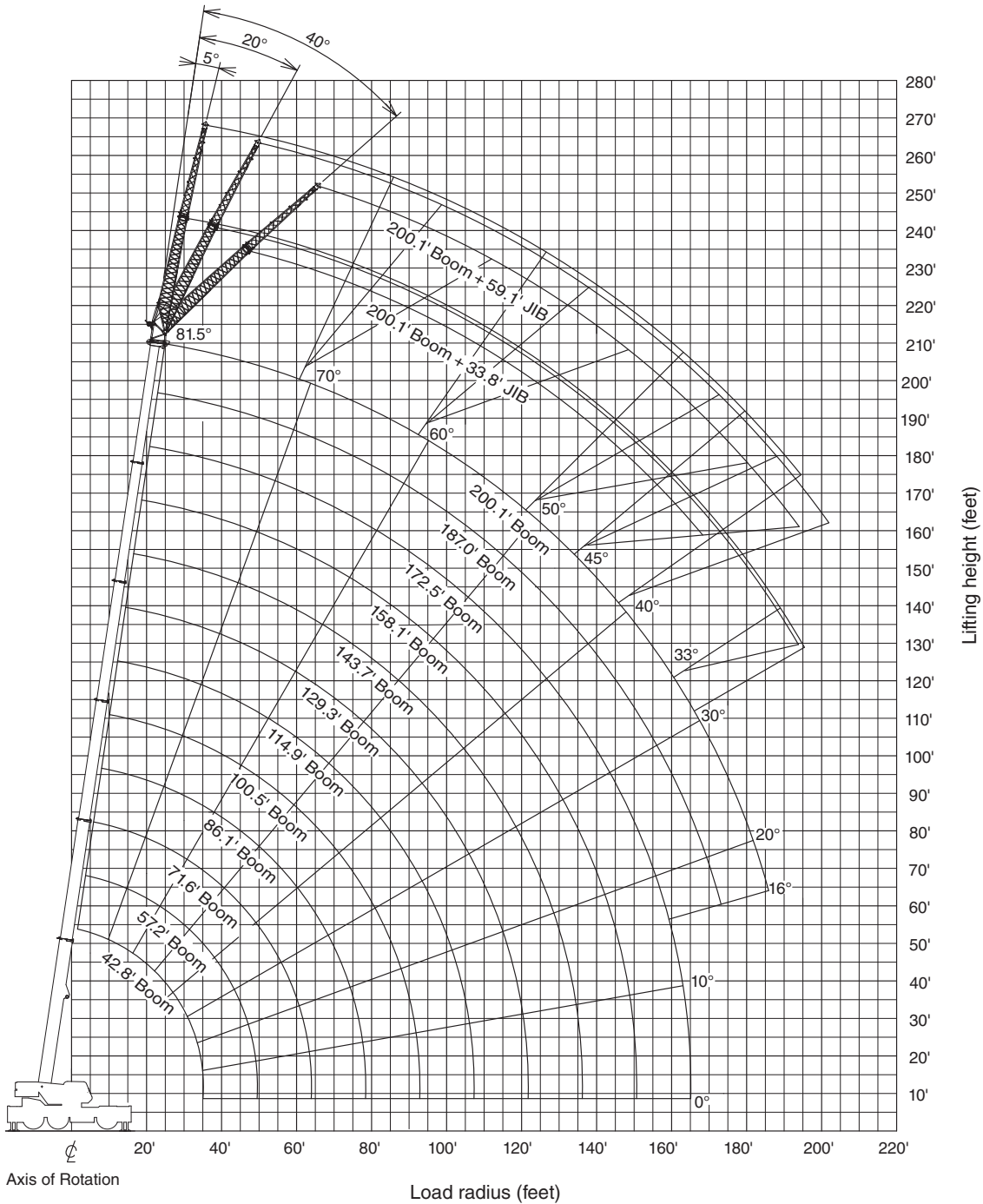

BOOM

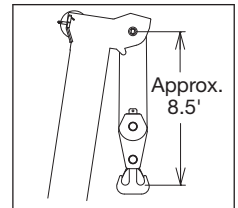

JIB

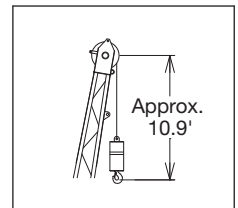

SINGLE TOP

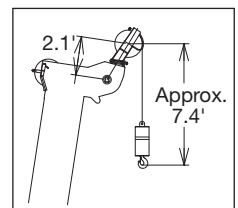

NOTE:
 Boom and jib geometry shown are for unloaded condition and machine standing level on firm supporting surface. Boom deflection and subsequent radius and boom angle change must be accounted for when applying load to hook.

Operation

Fully extended – 360°

64,600 lb		26'10-7/8" spread											360°	
42.8'		57.2'	71.6'	86.1'	100.5'	114.9'	129.3'	143.7'	158.1'	172.5'	187.0'	200.1'		
ft	1,000 lb											ft		
8	320,000*	200,000	174,200	-	-	-	-	-	-	-	-	-	-	8
10	241,800	200,000	174,200	127,000	-	-	-	-	-	-	-	-	-	10
12	218,000	200,000	174,200	145,500	-	-	-	-	-	-	-	-	-	12
15	187,200	182,800	174,200	145,500	111,800	-	-	-	-	-	-	-	-	15
20	148,400	148,800	145,500	138,700	106,300	84,700	57,300	-	-	-	-	-	-	20
25	121,500	122,400	122,800	120,800	106,300	77,600	66,400	48,700	-	-	-	-	-	25
30	101,000	102,500	102,700	102,100	97,700	77,600	61,100	52,700	37,900	-	-	-	-	30
35	48,700	85,100	85,300	84,700	86,200	74,700	54,900	48,900	41,700	33,100	-	-	-	35
45	-	64,200	62,400	64,200	63,300	63,500	46,700	43,000	37,700	33,100	26,500	22,900	-	45
50	-	-	54,700	56,200	55,600	57,100	43,900	39,200	35,500	32,000	26,500	22,900	-	50
60	-	-	45,400	44,300	46,100	45,200	38,800	33,500	31,100	28,400	26,000	22,900	-	60
65	-	-	-	41,000	41,400	40,300	36,600	31,100	28,900	26,900	24,700	22,700	-	65
75	-	-	-	32,600	33,500	32,600	33,100	27,100	24,900	24,000	22,300	20,500	-	75
80	-	-	-	-	30,200	29,500	30,400	25,400	23,600	22,500	21,200	19,600	-	80
90	-	-	-	-	23,600	26,000	24,700	22,500	21,200	19,800	19,200	17,600	-	90
95	-	-	-	-	-	23,800	22,500	21,400	20,100	18,700	18,100	16,500	-	95
105	-	-	-	-	-	18,500	18,700	19,000	18,100	17,000	16,300	14,800	-	105
110	-	-	-	-	-	-	17,200	17,900	16,800	16,300	15,700	14,100	-	110
120	-	-	-	-	-	-	12,800	15,200	14,100	15,000	13,900	12,600	-	120
125	-	-	-	-	-	-	-	14,100	13,400	13,700	12,800	11,900	-	125
130	-	-	-	-	-	-	-	13,000	12,800	12,600	11,700	11,200	-	130
140	-	-	-	-	-	-	-	-	11,500	10,800	9,700	9,700	-	140
145	-	-	-	-	-	-	-	-	10,600	9,900	9,000	9,000	-	145
155	-	-	-	-	-	-	-	-	-	8,400	7,500	7,500	-	155
160	-	-	-	-	-	-	-	-	-	7,900	6,800	6,600	-	160
170	-	-	-	-	-	-	-	-	-	-	5,500	5,500	-	170
175	-	-	-	-	-	-	-	-	-	-	4,900	4,900	-	175
180	-	-	-	-	-	-	-	-	-	-	-	4,400	-	180
185	-	-	-	-	-	-	-	-	-	-	-	3,700	-	185

* Over front with special equipment



NOTE:

In this table, the thick line which divides strength area and stability area is not shown because the figure of this table is indicated the best performance at the same boom length among the plural telescopic boom patterns.

Operation

MB

On rubber stationary

0 lb		0° *		
		42.8'	57.2'	71.6'
 1)		1)		
ft	1,000 lb			
8	73° 22,000	78° 22,000	81° 22,000	
10	70° 22,000	76° 22,000	79° 22,000	
12	67° 22,000	73° 22,000	77° 22,000	
15	63° 22,000	70° 22,000	75° 22,000	
20	54° 14,800	65° 18,100	71° 19,600	
25	45° 9,000	59° 12,300	66° 14,100	
30	33° 3,500	53° 7,700	62° 9,700	
35	-	45° 4,000	57° 6,000	
	4	4	4	
2)	0°	45°	57°	



Telescopic conditions (%)

	2.	0	0	0
	3.	0	0	0
	4.	0	0	0
	5.	0	0	0
	Top	0	45	90

* over front

1) Loaded boom angle (°)

2) Minimum boom angle (°) for indicator length (no load)

0 lb		360°		
		42.8'	57.2'	71.6'
 1)		1)		
ft	1,000 lb			
8	73° 22,000	78° 22,000	81° 22,000	
10	70° 22,000	76° 22,000	79° 22,000	
12	67° 20,500	73° 22,000	77° 22,000	
15	63° 13,700	70° 17,400	75° 19,400	
20	54° 6,200	65° 9,900	71° 12,100	
25	-	59° 4,900	66° 7,100	
30	-	-	62° 3,300	
35	-	-	-	
	4	4	4	
2)	54°	59°	62°	

Telescopic conditions (%)

	2.	0	0	0
	3.	0	0	0
	4.	0	0	0
	5.	0	0	0
	Top	0	45	90

Operation



Hydraulic offset jib – Counterweight 64,600 lb

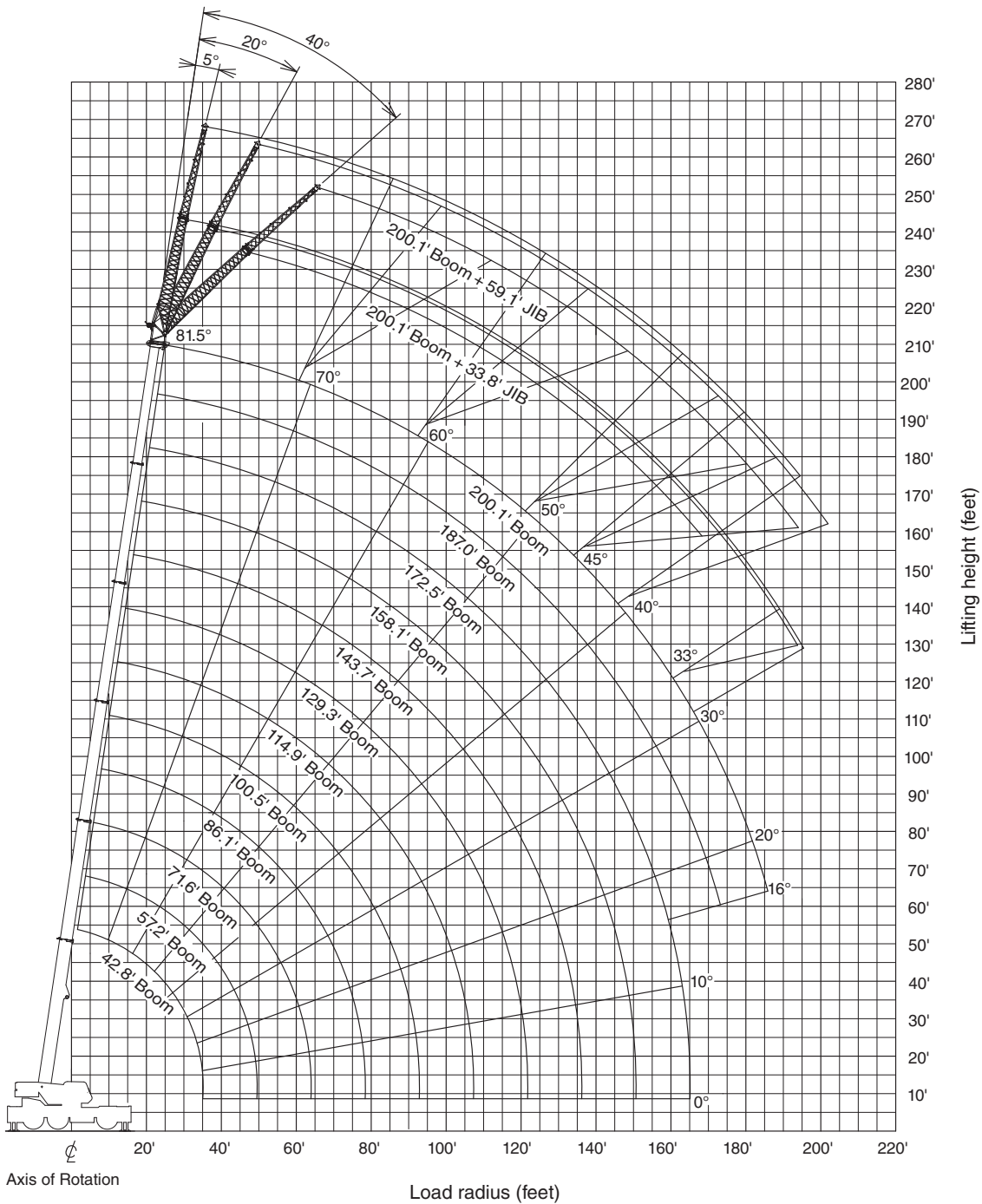

BOOM

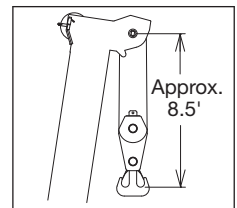

JIB

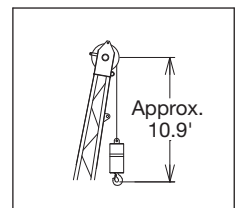

SINGLE TOP

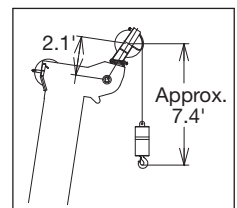

NOTE:
 Boom and jib geometry shown are for unloaded condition and machine standing level on firm supporting surface. Boom deflection and subsequent radius and boom angle change must be accounted for when applying load to hook.

Fully extended – 360° – with hydraulic offset jib

64,600 lb						26'10-7/8" spread						33.8'						360°					
200.1'												187.0'											
5° 5° 20° 20° 40° 40°												5° 5° 20° 20° 40° 40°											
1)												1)											
2)												2)											
1,000 lb												1,000 lb											
81.5°	48.2'	12,100	57.1'	12,100	66.9'	11,200	81.5°	42.3'	13,700	51.5'	13,700	61.4'	12,800										
81°	51.2'	12,100	61.0'	12,100	69.2'	11,000	81°	44.9'	13,700	54.1'	13,700	63.3'	12,600										
80°	56.4'	12,100	65.3'	11,900	74.1'	10,800	80°	49.9'	13,700	58.7'	13,400	67.6'	12,100										
79°	61.7'	12,100	69.6'	11,500	78.7'	10,400	79°	54.8'	13,700	63.3'	13,000	71.9'	11,900										
78°	67.3'	12,100	74.1'	11,000	82.7'	10,100	78°	59.7'	13,700	67.6'	12,600	75.5'	11,500										
77°	71.9'	11,900	80.1'	10,800	86.9'	9,900	77°	64.3'	13,700	71.9'	12,300	79.7'	11,200										
76°	76.4'	11,500	83.0'	10,400	91.2'	9,700	76°	68.2'	13,200	76.1'	11,900	83.3'	10,800										
75°	80.4'	11,000	87.6'	10,100	94.8'	9,300	75°	72.5'	12,800	79.7'	11,500	87.3'	10,600										
73°	89.6'	10,600	96.1'	9,700	103.0'	8,800	73°	80.7'	11,900	87.9'	10,800	94.8'	10,100										
70°	102.0'	9,500	108.0'	8,800	114.0'	8,400	70°	92.5'	11,000	99.4'	10,100	105.0'	9,500										
68°	110.0'	9,000	116.0'	8,400	121.0'	7,900	68°	100.0'	10,400	106.0'	9,500	112.0'	9,000										
65°	122.0'	8,400	127.0'	7,900	132.0'	7,500	65°	111.0'	9,500	117.0'	8,800	122.0'	8,400										
63°	129.0'	7,900	134.0'	7,500	138.0'	7,300	63°	118.0'	9,300	124.0'	8,600	128.0'	8,200										
60°	139.0'	7,300	144.0'	6,800	148.0'	6,600	60°	128.0'	8,600	133.0'	8,200	137.0'	7,700										
58°	146.0'	6,800	151.0'	6,600	154.0'	6,400	58°	135.0'	8,200	139.0'	7,700	143.0'	7,500										
55°	155.0'	6,200	159.0'	6,000	163.0'	6,000	55°	144.0'	7,700	148.0'	7,300	151.0'	7,100										
53°	161.0'	6,000	165.0'	5,700	168.0'	5,500	53°	150.0'	7,300	154.0'	7,100	156.0'	6,800										
50°	169.0'	5,300	173.0'	5,100	175.0'	4,900	50°	158.0'	6,800	161.0'	6,400	164.0'	6,400										
48°	175.0'	4,900	178.0'	4,600	180.0'	4,600	48°	163.0'	6,400	166.0'	6,200	168.0'	6,000										
45°	182.0'	4,400	185.0'	4,200	186.0'	4,200	45°	170.0'	5,700	173.0'	5,500	174.0'	5,500										
43°	187.0'	4,000	190.0'	4,000	-	-	43°	174.0'	5,300	177.0'	5,300	-	-										
40°	193.0'	3,500	195.0'	3,300	-	-	40°	180.0'	4,900	183.0'	4,600	-	-										
38°	197.0'	3,100	199.0'	2,900	-	-	38°	184.0'	4,400	186.0'	4,200	-	-										
35°	202.0'	2,400	204.0'	2,400	-	-	35°	190.0'	3,700	191.0'	3,500	-	-										
33°	206.0'	2,200	207.0'	2,000	-	-	33°	193.0'	3,500	194.0'	3,300	-	-										
30°	210.0'	1,800	-	-	-	-	30°	198.0'	2,900	198.0'	2,900	-	-										
28°	-	-	-	-	-	-	28°	200.0'	2,600	201.0'	2,600	-	-										
25°	-	-	-	-	-	-	25°	204.0'	2,400	203.0'	2,200	-	-										
23°	-	-	-	-	-	-	23°	206.0'	2,200	-	-	-	-										
20°	-	-	-	-	-	-	20°	208.0'	2,000	-	-	-	-										
	1		1		1			1		1		1											

1) Loaded boom angle (°)

2) Rated lifting capacity in pounds

Fully extended – 360° – with hydraulic offset jib

64,600 lb						26'10-7/8" spread						33.8'						360°					
						172.5'												114.9'					
						5° 5° 20° 20° 40° 40°												5° 5° 20° 20° 40° 40°					
						1,000 lb												1,000 lb					
81.5°	37.1'	15,900	46.9'	15,900	57.1'	15,000	81.5°	-	-	29.2'	23,400	37.1'	16,100										
81°	39.4'	15,900	49.2'	15,900	59.1'	14,800	81°	-	-	30.5'	23,100	38.4'	15,900										
80°	44.0'	15,900	53.5'	15,900	63.0'	14,300	80°	-	-	33.1'	22,500	41.0'	15,700										
79°	48.6'	15,900	57.7'	15,400	66.6'	13,900	79°	-	-	35.8'	22,000	43.3'	15,400										
78°	52.8'	15,900	61.7'	15,000	70.2'	13,400	78°	-	-	39.0'	21,400	45.9'	15,200										
77°	57.4'	15,900	65.3'	14,600	73.8'	13,000	77°	-	-	41.3'	20,900	48.6'	15,200										
76°	61.7'	15,900	69.2'	14,100	77.4'	12,800	76°	-	-	43.6'	20,500	50.9'	15,000										
75°	64.3'	15,200	73.2'	13,700	80.7'	12,300	75°	38.7'	28,200	46.3'	20,100	53.1'	14,800										
73°	72.2'	14,300	80.1'	12,800	87.6'	11,900	73°	44.0'	26,900	51.2'	19,200	57.7'	14,300										
70°	84.3'	13,000	90.6'	11,900	97.1'	11,000	70°	51.2'	24,900	58.7'	18,100	64.6'	13,900										
68°	91.5'	12,300	97.8'	11,500	104.0'	10,600	68°	56.4'	23,800	63.3'	17,400	68.9'	13,700										
65°	102.0'	11,500	107.0'	10,600	113.0'	9,900	65°	63.3'	22,300	70.2'	16,800	75.1'	13,400										
63°	109.0'	11,000	114.0'	10,100	118.0'	9,700	63°	67.9'	21,200	74.8'	16,300	79.4'	13,200										
60°	118.0'	10,100	123.0'	9,700	127.0'	9,300	60°	74.8'	19,800	81.4'	15,700	85.3'	13,000										
58°	124.0'	9,700	129.0'	9,300	133.0'	8,800	58°	79.1'	19,200	85.3'	15,200	89.2'	12,800										
55°	133.0'	9,000	137.0'	8,600	140.0'	8,400	55°	85.3'	18,100	91.5'	14,800	94.8'	12,600										
53°	138.0'	8,600	142.0'	8,400	145.0'	7,900	53°	89.2'	17,400	95.1'	14,300	98.1'	12,600										
50°	146.0'	8,200	149.0'	7,700	151.0'	7,500	50°	95.1'	16,800	101.0'	14,100	103.0'	12,600										
48°	151.0'	7,700	154.0'	7,300	156.0'	7,100	48°	99.0'	16,300	104.0'	13,900	106.0'	12,300										
45°	157.0'	7,100	160.0'	6,600	162.0'	6,600	45°	104.0'	15,700	109.0'	13,400	111.0'	12,300										
43°	162.0'	6,600	164.0'	6,400	-	-	43°	107.0'	15,400	112.0'	13,400	-	-										
40°	168.0'	6,000	170.0'	5,700	-	-	40°	112.0'	15,000	116.0'	13,200	-	-										
38°	171.0'	5,500	173.0'	5,300	-	-	38°	115.0'	14,600	119.0'	13,000	-	-										
35°	176.0'	4,900	178.0'	4,600	-	-	35°	120.0'	14,300	123.0'	13,000	-	-										
33°	179.0'	4,400	181.0'	4,200	-	-	33°	122.0'	14,100	125.0'	12,800	-	-										
30°	183.0'	3,700	185.0'	3,700	-	-	30°	126.0'	13,900	129.0'	12,800	-	-										
28°	186.0'	3,500	187.0'	3,300	-	-	28°	128.0'	13,200	131.0'	12,800	-	-										
						1												2					

1) Loaded boom angle (°)

2) Rated lifting capacity in pounds

Operation

Fully extended – 360° – with hydraulic offset jib

64,600 lb							26'10-7/8" spread							59.1'							360°						
							200.1'														187.0'						
							5° 5° 20° 20° 40° 40°														5° 5° 20° 20° 40° 40°						
							1) 2) 2) 2)														1) 2) 2) 2)						
							1,000 lb														1,000 lb						
81.5°	56.1'	8,200	72.2'	8,200	88.9'	7,100	81.5°	47.9'	8,800	65.6'	8,800	81.0'	7,300														
81°	59.1'	8,200	74.5'	8,200	91.9'	7,100	81°	49.2'	8,800	68.2'	8,800	83.7'	7,300														
80°	65.3'	8,200	81.0'	8,200	97.1'	6,800	80°	56.4'	8,800	73.8'	8,800	88.6'	7,100														
79°	70.9'	8,200	86.3'	8,200	102.0'	6,800	79°	61.7'	8,800	78.1'	8,600	92.8'	7,100														
78°	76.8'	8,200	91.5'	7,900	107.0'	6,600	78°	66.6'	8,800	83.3'	8,400	97.4'	7,100														
77°	82.0'	8,200	96.1'	7,700	112.0'	6,600	77°	71.9'	8,800	87.6'	8,200	102.0'	6,800														
76°	87.9'	8,200	101.0'	7,500	116.0'	6,600	76°	77.1'	8,800	92.5'	7,900	106.0'	6,800														
75°	93.5'	8,200	106.0'	7,300	119.0'	6,400	75°	82.0'	8,800	97.1'	7,900	110.0'	6,600														
73°	103.0'	7,700	115.0'	6,800	129.0'	6,200	73°	92.2'	8,800	106.0'	7,700	118.0'	6,600														
70°	117.0'	7,100	128.0'	6,400	140.0'	5,700	70°	106.0'	8,200	119.0'	7,300	129.0'	6,400														
68°	126.0'	6,800	135.0'	6,000	147.0'	5,500	68°	114.0'	7,700	127.0'	7,100	137.0'	6,200														
65°	138.0'	6,200	149.0'	5,700	158.0'	5,300	65°	126.0'	7,300	138.0'	6,600	147.0'	6,200														
63°	147.0'	6,000	156.0'	5,500	165.0'	5,100	63°	135.0'	7,100	146.0'	6,400	154.0'	6,000														
60°	159.0'	5,500	167.0'	5,100	175.0'	4,900	60°	146.0'	6,600	156.0'	6,000	163.0'	5,700														
58°	166.0'	5,100	174.0'	4,900	181.0'	4,600	58°	153.0'	6,400	163.0'	5,700	169.0'	5,500														
55°	176.0'	4,600	183.0'	4,400	189.0'	4,200	55°	163.0'	6,000	172.0'	5,500	177.0'	5,300														
53°	182.0'	4,200	189.0'	4,000	194.0'	3,700	53°	169.0'	5,500	177.0'	5,100	182.0'	4,900														
50°	191.0'	3,700	197.0'	3,500	200.0'	3,300	50°	177.0'	4,900	186.0'	4,600	189.0'	4,400														
48°	197.0'	3,300	201.0'	3,100	205.0'	3,100	48°	183.0'	4,600	190.0'	4,200	193.0'	4,200														
45°	205.0'	2,900	209.0'	2,600	211.0'	2,400	45°	191.0'	4,000	198.0'	3,700	199.0'	3,700														
43°	210.0'	2,600	213.0'	2,400	-	-	43°	196.0'	3,700	202.0'	3,500	-	-														
40°	216.0'	2,000	219.0'	1,800	-	-	40°	202.0'	3,300	207.0'	2,900	-	-														
38°	-	-	-	-	-	-	38°	207.0'	2,900	211.0'	2,600	-	-														
35°	-	-	-	-	-	-	35°	212.0'	2,200	216.0'	2,000	-	-														
33°	-	-	-	-	-	-	33°	216.0'	2,000	219.0'	1,800	-	-														
							1							1							1						

1) Loaded boom angle (°)

2) Rated lifting capacity in pounds

Fully extended – 360° – with hydraulic offset jib

64,600 lb						26'10-7/8" spread						59.1'						360°					
172.5'												114.9'											
5°		5°		20°		20°		40°		40°		5°		5°		20°		20°		40°		40°	
1)		2)		2)		2)		2)		1)		2)		2)		2)		2)		2)		2)	
1,000 lb												1,000 lb											
81.5°	44.9'	10,400	61.7'	9,700	76.1'	7,500	81.5°	30.2'	14,100	44.6'	11,900	58.7'	8,200										
81°	47.6'	10,400	64.3'	9,700	78.4'	7,500	81°	31.5'	14,100	45.9'	11,700	60.4'	8,200										
80°	52.8'	10,400	69.2'	9,500	82.7'	7,500	80°	35.1'	14,100	49.2'	11,500	63.3'	7,900										
79°	57.7'	10,400	73.5'	9,300	86.6'	7,300	79°	38.4'	14,100	52.5'	11,200	65.9'	7,900										
78°	63.0'	10,400	78.1'	9,000	90.9'	7,300	78°	41.7'	14,100	55.4'	11,000	68.6'	7,900										
77°	67.3'	10,400	82.0'	8,800	94.8'	7,300	77°	44.6'	14,100	58.4'	10,600	71.2'	7,700										
76°	72.2'	10,400	86.3'	8,600	98.1'	7,100	76°	47.9'	14,100	61.0'	10,400	73.8'	7,700										
75°	76.8'	10,400	90.9'	8,600	102.0'	7,100	75°	51.2'	14,100	64.0'	10,100	76.4'	7,700										
73°	86.6'	10,100	98.8'	8,200	110.0'	6,800	73°	57.1'	13,200	70.2'	9,900	81.7'	7,500										
70°	98.0'	9,500	111.0'	7,700	120.0'	6,600	70°	65.9'	12,300	74.8'	9,300	88.9'	7,300										
68°	114.0'	9,300	118.0'	7,500	127.0'	6,600	68°	71.5'	11,700	83.7'	9,000	93.5'	7,100										
65°	119.0'	8,800	129.0'	7,300	136.0'	6,400	65°	80.1'	11,000	91.5'	8,600	100.0'	7,100										
63°	126.0'	8,400	135.0'	7,100	143.0'	6,400	63°	85.3'	10,600	96.5'	8,400	105.0'	7,100										
60°	136.0'	7,900	146.0'	6,800	152.0'	6,200	60°	93.2'	10,100	104.0'	7,900	112.0'	6,800										
58°	143.0'	7,500	153.0'	6,800	157.0'	6,200	58°	98.1'	9,700	109.0'	7,900	116.0'	6,800										
55°	153.0'	7,100	162.0'	6,600	165.0'	6,200	55°	105.0'	9,300	115.0'	7,500	122.0'	6,800										
53°	159.0'	6,600	167.0'	6,200	170.0'	6,000	53°	110.0'	9,000	120.0'	7,500	125.0'	6,600										
50°	167.0'	6,000	174.0'	5,500	176.0'	5,300	50°	117.0'	8,600	126.0'	7,300	130.0'	6,600										
48°	173.0'	5,500	179.0'	5,300	180.0'	5,100	48°	121.0'	8,400	130.0'	7,300	134.0'	6,600										
45°	180.0'	5,100	186.0'	4,900	186.0'	4,600	45°	127.0'	8,200	135.0'	7,100	138.0'	6,600										
43°	185.0'	4,900	190.0'	4,400	-	-	43°	131.0'	7,900	138.0'	7,100	-	-										
40°	191.0'	4,200	195.0'	3,700	-	-	40°	136.0'	7,700	143.0'	6,800	-	-										
38°	196.0'	3,700	199.0'	3,300	-	-	38°	143.0'	7,500	146.0'	6,800	-	-										
35°	201.0'	3,100	204.0'	2,900	-	-	35°	145.0'	7,300	150.0'	6,800	-	-										
33°	205.0'	2,900	207.0'	2,600	-	-	33°	148.0'	7,300	153.0'	6,800	-	-										
30°	210.0'	2,400	211.0'	2,200	-	-	30°	152.0'	7,100	156.0'	6,800	-	-										
28°	213.0'	2,200	213.0'	2,000	-	-	28°	155.0'	7,100	158.0'	6,800	-	-										
1		1		1		1		1		1		1											

1) Loaded boom angle (°)

2) Rated lifting capacity in pounds

Operation

Fully extended – 360° – with insert jib + hydraulic offset jib

64,600 lb							26'10-7/8" spread							59.1'		23.0'		360°	
200.1'							187.0'												
5° 5° 20° 20° 40° 40°							5° 5° 20° 20° 40° 40°												
1) 2) 2) 2)							1) 2) 2) 2)												
1,000 lb							1,000 lb												
81.5°	63.4'	6,800	79.6'	6,400	95.4'	5,700	81.5°	57.5'	7,500	73.1'	7,100	88.4'	6,000						
81°	66.7'	6,800	82.8'	6,400	98.4'	5,700	81°	60.2'	7,500	76.2'	7,100	91.4'	6,000						
80°	73.3'	6,800	89.8'	6,400	105.0'	5,700	80°	66.6'	7,500	82.4'	7,100	96.8'	6,000						
79°	79.9'	6,800	95.3'	6,200	110.0'	5,700	79°	72.9'	7,500	88.3'	7,100	102.0'	6,000						
78°	86.4'	6,800	101.0'	6,000	115.0'	5,500	78°	78.5'	7,500	94.3'	6,800	107.0'	5,700						
77°	92.1'	6,600	107.0'	6,000	120.0'	5,300	77°	84.3'	7,500	99.1'	6,600	112.0'	5,700						
76°	97.9'	6,400	112.0'	5,700	125.0'	5,100	76°	89.8'	7,300	104.0'	6,400	117.0'	5,700						
75°	103.0'	6,200	117.0'	5,500	130.0'	5,100	75°	94.8'	7,100	109.0'	6,200	121.0'	5,500						
73°	113.0'	5,700	126.0'	5,100	138.0'	4,600	73°	105.0'	6,600	118.0'	6,000	130.0'	5,300						
70°	129.0'	5,300	141.0'	4,600	151.0'	4,400	70°	119.0'	6,200	132.0'	5,500	142.0'	5,100						
68°	138.0'	4,900	150.0'	4,400	159.0'	4,200	68°	129.0'	6,000	140.0'	5,300	150.0'	4,900						
65°	152.0'	4,400	163.0'	4,200	171.0'	4,000	65°	142.0'	5,500	153.0'	5,100	161.0'	4,600						
63°	162.0'	4,200	171.0'	4,000	178.0'	3,700	63°	150.0'	5,100	161.0'	4,900	169.0'	4,600						
60°	174.0'	4,000	184.0'	3,700	189.0'	3,500	60°	163.0'	4,900	173.0'	4,400	179.0'	4,200						
58°	182.0'	3,700	191.0'	3,500	196.0'	3,300	58°	171.0'	4,600	180.0'	4,200	186.0'	4,200						
55°	193.0'	3,300	201.0'	3,100	205.0'	2,900	55°	182.0'	4,400	190.0'	4,000	194.0'	4,000						
53°	200.0'	2,900	207.0'	2,600	210.0'	2,600	53°	188.0'	4,000	197.0'	3,700	199.0'	3,500						
50°	209.0'	2,400	216.0'	2,200	218.0'	2,000	50°	197.0'	3,300	204.0'	3,300	206.0'	3,100						
48°	215.0'	2,000	-	-	-	-	48°	203.0'	3,100	209.0'	2,600	211.0'	2,600						
45°	-	-	-	-	-	-	45°	210.0'	2,400	216.0'	2,200	217.0'	2,000						
43°	-	-	-	-	-	-	43°	216.0'	2,200	221.0'	1,800	-	-						
	1		1		1			1		1		1							

1) Loaded boom angle (°)

2) Rated lifting capacity in pounds

Operation

Fully extended – 360° – with insert jib + hydraulic offset jib

64,600 lb							26'10-7/8" spread							59.1'							23.0'							360°													
172.5'														114.9'																											
5°							5°							20°							20°							40°							40°						
1)							2)							2)							2)							2)							2)						
1,000 lb														1,000 lb																											
81.5°	51.9'	8,600	68.4'	7,900	82.4'	6,200	81.5°	33.2'	11,900	48.4'	9,900	63.5'	7,300																												
81°	54.9'	8,600	70.9'	7,900	84.8'	6,200	81°	35.3'	11,900	50.3'	9,900	65.4'	7,300																												
80°	60.5'	8,600	76.8'	7,900	89.9'	6,200	80°	39.3'	11,900	54.2'	9,900	69.0'	7,300																												
79°	66.0'	8,600	81.5'	7,700	94.7'	6,200	79°	42.9'	11,900	57.6'	9,700	72.0'	7,100																												
78°	71.5'	8,600	86.2'	7,500	99.4'	6,200	78°	46.8'	11,900	61.0'	9,300	75.1'	7,100																												
77°	76.9'	8,600	91.2'	7,300	104.0'	6,000	77°	50.4'	11,900	64.4'	9,000	78.2'	6,800																												
76°	82.3'	8,600	95.8'	7,100	108.0'	6,000	76°	53.9'	11,700	67.7'	8,800	81.2'	6,600																												
75°	87.0'	8,400	100.0'	6,800	112.0'	5,700	75°	57.3'	11,200	71.0'	8,400	84.2'	6,600																												
73°	96.5'	7,900	109.0'	6,600	120.0'	5,500	73°	64.3'	10,600	77.6'	7,900	90.0'	6,200																												
70°	110.0'	7,300	122.0'	6,200	132.0'	5,300	70°	74.1'	9,500	86.8'	7,300	98.5'	6,000																												
68°	119.0'	7,100	131.0'	6,000	139.0'	5,100	68°	80.4'	8,800	93.1'	7,100	104.0'	5,700																												
65°	132.0'	6,600	143.0'	5,500	150.0'	4,900	65°	89.9'	8,200	102.0'	6,600	112.0'	5,500																												
63°	139.0'	6,200	150.0'	5,300	157.0'	4,900	63°	95.9'	7,700	108.0'	6,200	117.0'	5,300																												
60°	151.0'	6,000	161.0'	5,100	167.0'	4,600	60°	105.0'	7,100	116.0'	6,000	124.0'	5,100																												
58°	159.0'	5,700	168.0'	5,100	173.0'	4,600	58°	110.0'	6,600	121.0'	5,700	129.0'	4,900																												
55°	169.0'	5,300	178.0'	4,900	182.0'	4,400	55°	119.0'	6,200	129.0'	5,300	136.0'	4,900																												
53°	175.0'	4,900	184.0'	4,600	187.0'	4,400	53°	124.0'	6,000	134.0'	5,300	140.0'	4,600																												
50°	184.0'	4,400	192.0'	4,000	194.0'	4,000	50°	132.0'	5,700	141.0'	5,100	146.0'	4,600																												
48°	190.0'	4,000	197.0'	3,700	199.0'	3,500	48°	137.0'	5,500	145.0'	4,900	149.0'	4,400																												
45°	198.0'	3,500	203.0'	3,100	205.0'	2,900	45°	144.0'	5,300	151.0'	4,600	154.0'	4,400																												
43°	202.0'	3,100	207.0'	2,600	-	-	43°	148.0'	5,100	155.0'	4,600	-	-																												
40°	209.0'	2,400	213.0'	2,000	-	-	40°	154.0'	4,900	161.0'	4,400	-	-																												
38°	213.0'	2,000	217.0'	1,800	-	-	38°	158.0'	4,600	164.0'	4,400	-	-																												
35°	-	-	-	-	-	-	35°	164.0'	4,600	169.0'	4,200	-	-																												
33°	-	-	-	-	-	-	33°	167.0'	4,400	171.0'	4,200	-	-																												
30°	-	-	-	-	-	-	30°	171.0'	4,400	175.0'	4,200	-	-																												
28°	-	-	-	-	-	-	28°	174.0'	4,400	177.0'	4,200	-	-																												
25°	-	-	-	-	-	-	25°	178.0'	4,200	180.0'	4,200	-	-																												
23°	-	-	-	-	-	-	23°	180.0'	4,200	-	-	-	-																												
	1						1						1																												

- 1) Loaded boom angle (°)
- 2) Rated lifting capacity in pounds

Operation



Hydraulic offset jib – 23.0' insert jib (option) – Counterweight 64,600 lb

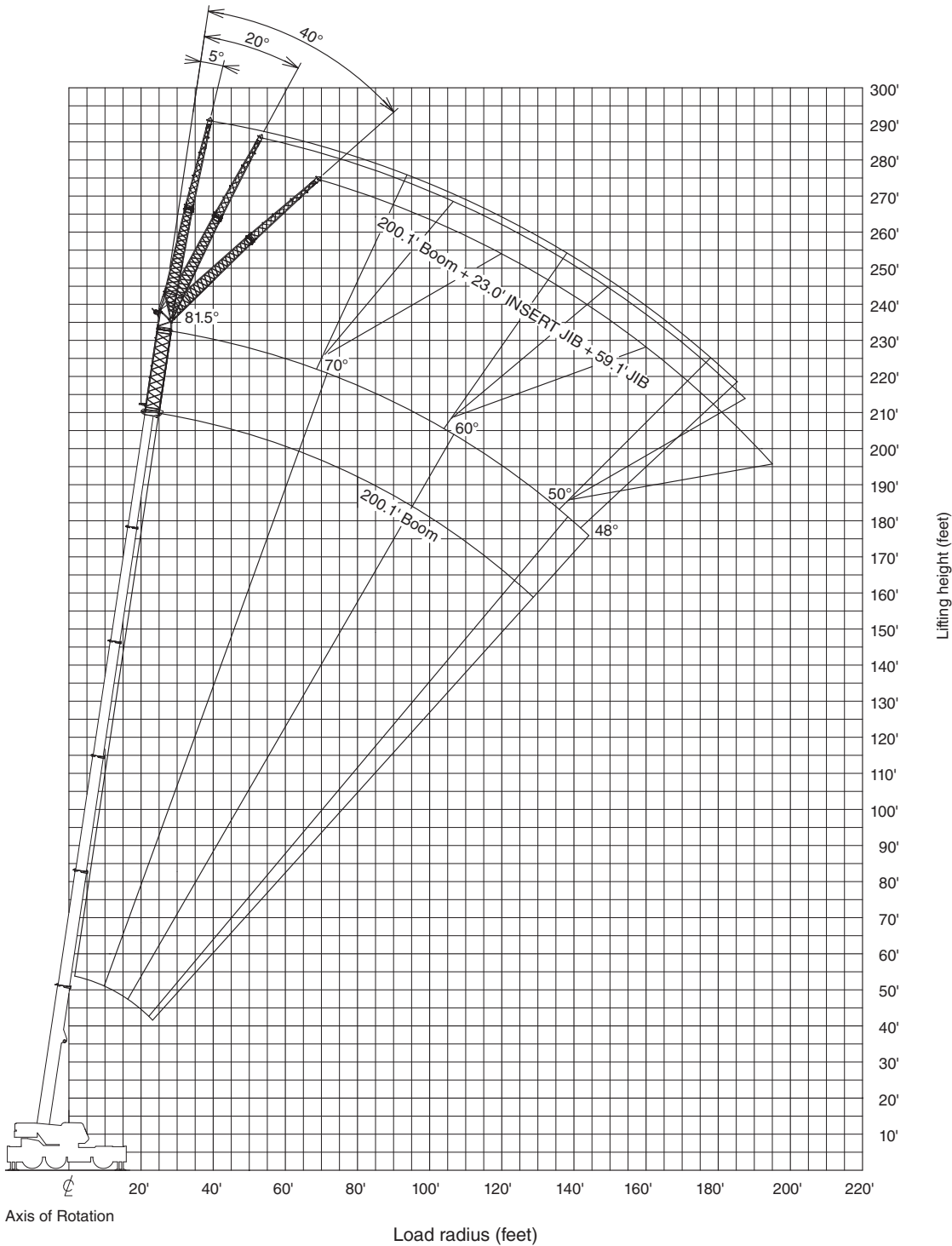

BOOM

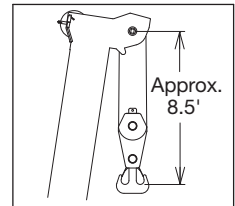

JIB

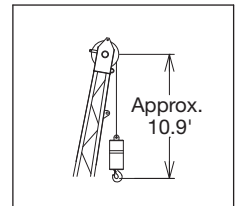

SINGLE TOP

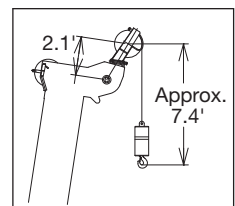

NOTE:
 Boom and jib geometry shown are for unloaded condition and machine standing level on firm supporting surface. Boom deflection and subsequent radius and boom angle change must be accounted for when applying load to hook.

Operation

Hydraulic offset jib – 45.9' insert jib (option) – Counterweight 64,600 lb

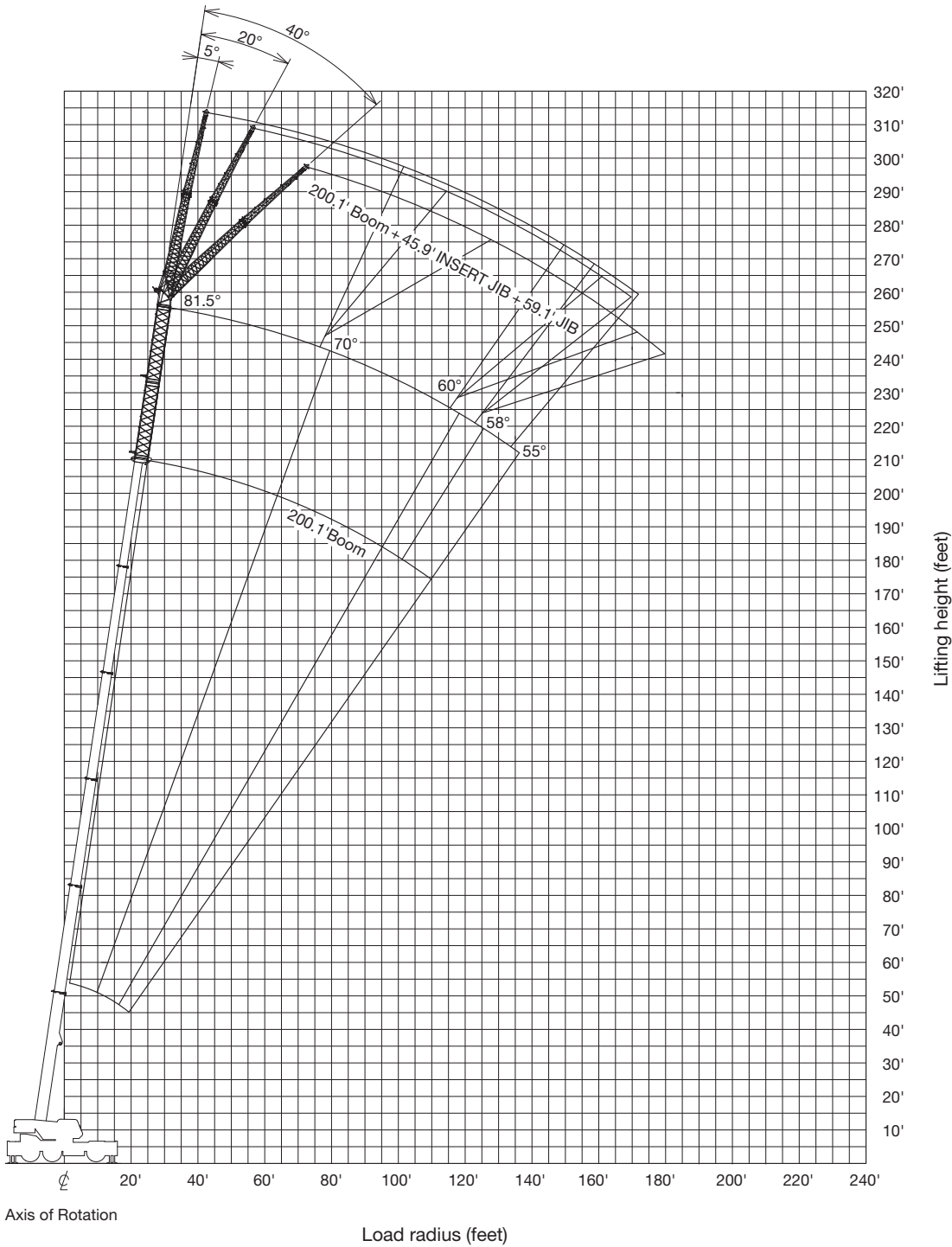

BOOM

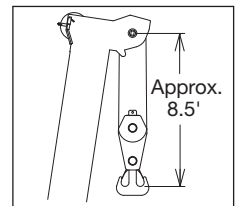

JIB

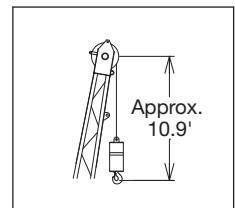

SINGLE TOP

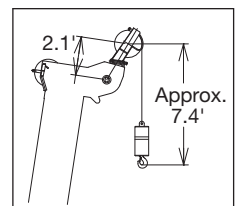

NOTE:
 Boom and jib geometry shown are for unloaded condition and machine standing level on firm supporting surface.
 Boom deflection and subsequent radius and boom angle change must be accounted for when applying load to hook.

Fully extended – 360° – with insert jib + hydraulic offset jib

64,600 lb							26'10-7/8" spread							59.1'							45.9'							360°																																																																																																																																																																																																																															
200.1'														187.0'																																																																																																																																																																																																																																													
5°							5°							20°							20°							40°							40°																																																																																																																																																																																																																								
1)							2)							2)							2)							2)							2)																																																																																																																																																																																																																								
1,000 lb														1,000 lb																																																																																																																																																																																																																																													
81.5°	70.7'	4,600	86.6'	4,600	105.0'	4,600	81.5°	65.2'	6,200	80.4'	5,300	97.2'	4,900	81°	74.3'	4,600	90.2'	4,600	109.0'	4,600	81°	68.7'	6,200	83.8'	5,300	100.0'	4,900	80°	82.1'	4,600	97.7'	4,600	115.0'	4,400	80°	75.0'	6,000	90.5'	5,300	107.0'	4,900	79°	89.0'	4,600	104.0'	4,600	121.0'	4,400	79°	81.7'	6,000	96.9'	5,300	112.0'	4,600	78°	97.5'	4,600	111.0'	4,600	126.0'	4,200	78°	87.7'	5,700	102.0'	5,100	117.0'	4,600	77°	103.0'	4,600	117.0'	4,400	131.0'	4,000	77°	93.7'	5,500	108.0'	4,900	122.0'	4,400	76°	110.0'	4,600	123.0'	4,200	137.0'	4,000	76°	99.2'	5,300	113.0'	4,900	127.0'	4,400	75°	116.0'	4,400	128.0'	4,000	142.0'	3,700	75°	106.0'	5,300	119.0'	4,600	132.0'	4,200	73°	128.0'	4,200	139.0'	3,700	152.0'	3,500	73°	116.0'	4,900	129.0'	4,400	141.0'	4,000	70°	144.0'	3,700	154.0'	3,300	165.0'	3,100	70°	132.0'	4,400	144.0'	4,000	155.0'	3,700	68°	155.0'	3,300	165.0'	3,100	174.0'	2,900	68°	143.0'	4,200	154.0'	3,700	164.0'	3,500	65°	170.0'	3,100	180.0'	2,900	187.0'	2,600	65°	157.0'	3,700	168.0'	3,500	177.0'	3,300	63°	180.0'	2,900	188.0'	2,600	195.0'	2,400	63°	166.0'	3,500	176.0'	3,300	184.0'	3,100	60°	194.0'	2,600	201.0'	2,400	208.0'	2,400	60°	180.0'	3,300	189.0'	3,100	196.0'	3,100	58°	202.0'	2,200	209.0'	2,200	214.0'	2,000	58°	188.0'	3,100	196.0'	2,900	203.0'	2,900	55°	213.0'	1,800	-	-	-	-	55°	199.0'	2,600	207.0'	2,600	212.0'	2,400	53°	-	-	-	-	-	-	53°	207.0'	2,400	213.0'	2,200	217.0'	2,200	50°	-	-	-	-	-	-	50°	216.0'	1,800	223.0'	1,800	226.0'	1,800
1							1							1							1																																																																																																																																																																																																																																						

- 1) Loaded boom angle (°)
- 2) Rated lifting capacity in pounds

Operation

Fully extended – 360° – with insert jib + hydraulic offset jib

64,600 lb		26'10-7/8" spread					59.1'	45.9'	360°				
		172.5'					114.9'						
		5°	5°	20°	20°	40°	40°						
		1)	2)	2)	2)	2)	1)	2)	2)	2)	2)		
1,000 lb						1,000 lb							
81.5°	59.0'	7,100	73.5'	6,000	90.1'	5,300	81.5°	39.4'	9,700	53.8'	7,900	69.6'	6,400
81°	62.3'	7,100	76.7'	6,000	92.7'	5,300	81°	42.0'	9,700	56.0'	7,900	71.7'	6,400
80°	68.3'	6,800	83.1'	6,000	98.8'	5,300	80°	46.1'	9,700	60.4'	7,900	75.4'	6,400
79°	74.1'	6,600	88.2'	5,700	103.0'	5,100	79°	50.4'	9,500	64.2'	7,700	79.2'	6,200
78°	79.4'	6,400	93.3'	5,500	109.0'	5,100	78°	54.4'	9,300	68.3'	7,500	82.7'	6,000
77°	85.8'	6,400	98.9'	5,500	113.0'	4,900	77°	58.3'	8,800	72.1'	7,300	85.7'	5,700
76°	91.0'	6,200	104.0'	5,300	118.0'	4,600	76°	62.5'	8,600	75.4'	6,800	89.1'	5,500
75°	96.3'	6,000	109.0'	5,100	122.0'	4,600	75°	66.0'	8,200	79.4'	6,600	92.8'	5,500
73°	107.0'	5,500	119.0'	4,900	132.0'	4,400	73°	74.0'	7,700	86.7'	6,400	99.0'	5,100
70°	122.0'	5,100	132.0'	4,400	144.0'	4,000	70°	84.9'	6,800	97.0'	5,700	109.0'	4,600
68°	132.0'	4,900	142.0'	4,200	153.0'	4,000	68°	92.3'	6,400	104.0'	5,300	115.0'	4,400
65°	145.0'	4,400	155.0'	4,000	165.0'	3,700	65°	103.0'	6,000	114.0'	4,900	124.0'	4,200
63°	154.0'	4,200	163.0'	3,700	172.0'	3,500	63°	109.0'	5,500	120.0'	4,600	129.0'	4,000
60°	167.0'	4,000	175.0'	3,500	183.0'	3,300	60°	119.0'	5,100	129.0'	4,200	138.0'	3,700
58°	175.0'	3,700	183.0'	3,300	190.0'	3,100	58°	126.0'	4,600	135.0'	4,000	143.0'	3,500
55°	187.0'	3,500	194.0'	3,300	200.0'	3,100	55°	135.0'	4,200	144.0'	3,700	151.0'	3,300
53°	193.0'	3,100	201.0'	3,100	205.0'	2,900	53°	141.0'	4,000	149.0'	3,500	155.0'	3,100
50°	202.0'	2,600	210.0'	2,600	213.0'	2,400	50°	149.0'	3,700	157.0'	3,300	162.0'	3,100
48°	209.0'	2,400	215.0'	2,200	218.0'	2,200	48°	155.0'	3,500	162.0'	3,100	166.0'	2,900
45°	217.0'	2,000	223.0'	2,000	225.0'	2,000	45°	162.0'	3,300	169.0'	2,900	172.0'	2,900
43°	223.0'	1,800	-	-	-	-	43°	167.0'	3,100	174.0'	2,900	-	-
40°	-	-	-	-	-	-	40°	174.0'	3,100	180.0'	2,600	-	-
38°	-	-	-	-	-	-	38°	178.0'	2,900	184.0'	2,600	-	-
35°	-	-	-	-	-	-	35°	184.0'	2,600	189.0'	2,600	-	-
33°	-	-	-	-	-	-	33°	188.0'	2,600	192.0'	2,400	-	-
30°	-	-	-	-	-	-	30°	193.0'	2,400	196.0'	2,400	-	-
28°	-	-	-	-	-	-	28°	196.0'	2,400	199.0'	2,400	-	-
25°	-	-	-	-	-	-	25°	200.0'	2,400	202.0'	2,200	-	-
23°	-	-	-	-	-	-	23°	202.0'	2,200	-	-	-	-
	1		1		1			1		1		1	

1) Loaded boom angle (°)

2) Rated lifting capacity in pounds

Operation



Short jib (option) – Counterweight 64,600 lb

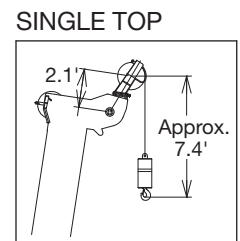
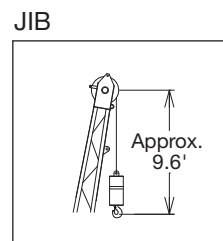
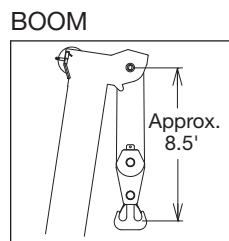
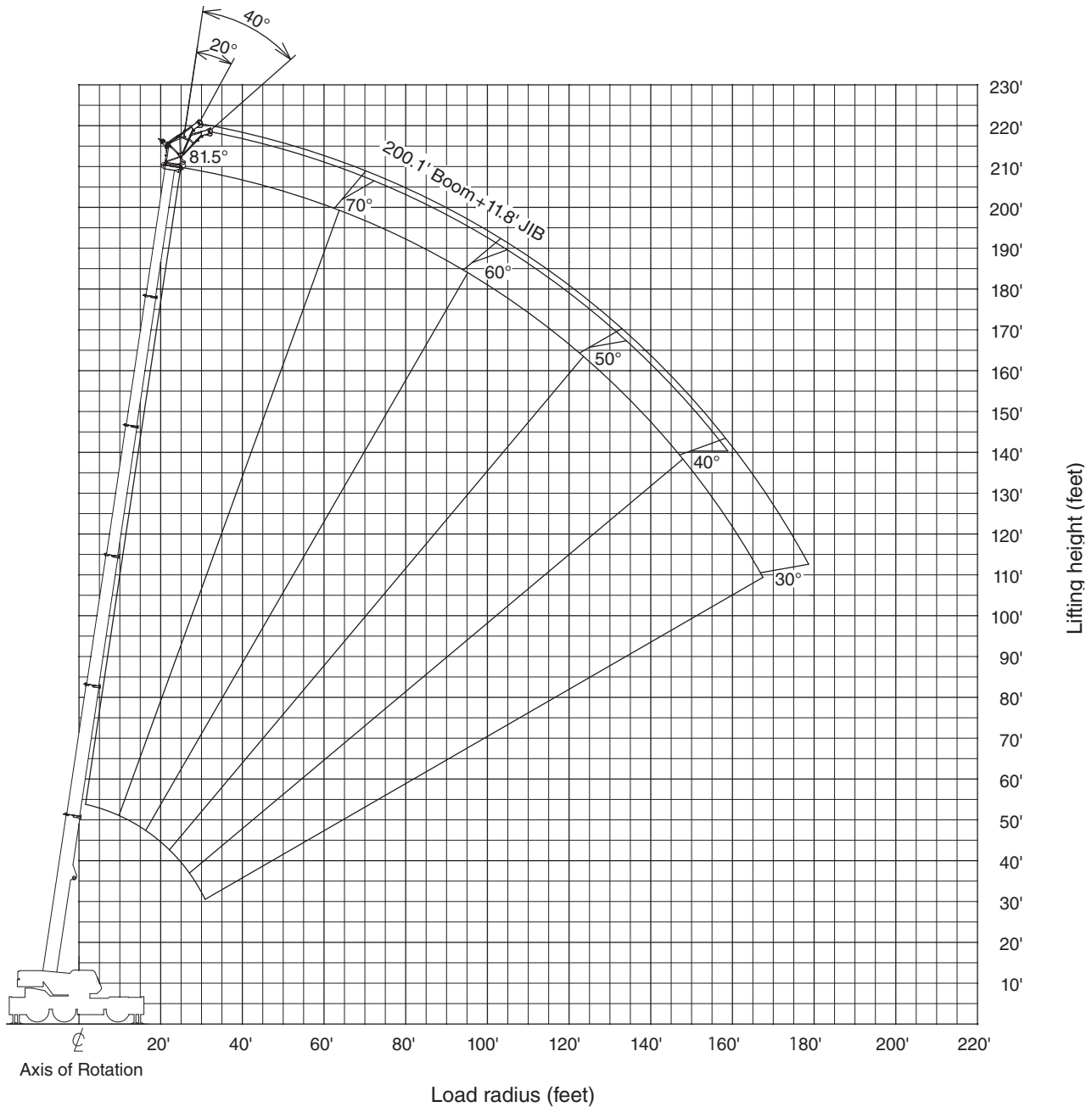

NOTE:
 Boom and jib geometry shown are for unloaded condition and machine standing level on firm supporting surface.
 Boom deflection and subsequent radius and boom angle change must be accounted for when applying load to hook.

Operation

Fully extended – 360° – with short jib

64,600 lb				26'10"-7/8" spread				11.8' short jib				360°				
200.1'				187.0'				172.5'				114.9'				
20°		40°		20°		40°		20°		40°		20°		40°		
1)		2)		2)		2)		2)		2)		2)		2)		
1,000 lb																
81.5°	46.3'	20,700	51.2'	20,300	41.7'	23,800	44.6'	23,100	36.7'	28,900	39.7'	27,800	21.3'	48,900	22.6'	39,700
81°	48.6'	20,300	53.1'	20,100	43.6'	23,600	46.6'	22,700	38.7'	28,400	41.7'	27,300	22.3'	48,500	23.6'	39,500
80°	52.8'	19,800	57.4'	19,400	47.6'	22,700	50.5'	22,000	42.3'	27,300	45.3'	26,200	24.6'	47,800	25.9'	39,000
79°	57.1'	19,200	61.4'	18,700	50.9'	22,000	53.8'	21,200	45.6'	26,500	48.6'	25,400	26.9'	47,000	28.2'	38,600
78°	60.7'	18,500	65.0'	18,100	54.5'	21,200	57.7'	20,500	49.2'	25,600	51.8'	24,500	29.2'	46,300	30.2'	38,400
77°	64.6'	17,900	68.6'	17,400	58.4'	20,500	61.0'	19,800	52.5'	24,700	55.1'	23,800	31.2'	45,600	32.5'	37,900
76°	68.6'	17,200	72.5'	17,000	61.7'	19,800	64.3'	19,200	55.8'	23,600	58.4'	22,900	33.5'	45,000	34.4'	37,700
75°	72.2'	16,500	76.1'	16,300	65.3'	19,200	67.9'	18,500	59.1'	22,700	61.4'	22,000	35.4'	44,300	36.7'	37,300
73°	79.7'	15,400	83.0'	15,200	72.2'	17,900	74.5'	17,400	65.3'	21,200	67.6'	20,500	39.7'	43,200	41.0'	36,800
70°	89.9'	13,900	93.5'	13,700	82.0'	16,300	84.3'	16,100	74.5'	19,000	76.4'	18,500	45.9'	41,700	46.9'	35,900
68°	96.8'	13,000	99.7'	12,800	88.3'	15,200	90.6'	15,000	80.1'	17,600	81.4'	17,400	50.2'	40,800	51.2'	35,700
65°	107.0'	11,700	110.0'	11,700	97.8'	13,900	99.4'	13,700	88.6'	16,100	90.6'	15,900	56.1'	39,700	57.1'	35,100
63°	113.0'	11,000	115.0'	10,800	104.0'	13,200	106.0'	13,000	94.2'	15,200	95.8'	15,000	60.0'	39,000	61.0'	34,800
60°	122.0'	9,900	124.0'	9,900	112.0'	11,900	114.0'	11,900	102.0'	13,900	104.0'	13,900	65.3'	37,300	66.3'	34,400
58°	128.0'	9,500	130.0'	9,300	118.0'	11,200	119.0'	11,200	107.0'	13,200	109.0'	13,000	68.9'	35,900	69.9'	34,200
55°	136.0'	8,600	138.0'	8,600	126.0'	10,400	127.0'	10,400	115.0'	12,300	116.0'	12,100	73.8'	33,500	75.1'	32,800
53°	142.0'	8,200	143.0'	7,700	131.0'	9,900	132.0'	9,900	120.0'	11,700	120.0'	11,500	77.1'	31,100	78.1'	30,400
50°	149.0'	6,800	149.0'	6,400	138.0'	8,800	138.0'	8,600	126.0'	10,400	127.0'	10,100	81.7'	27,800	82.3'	27,600
48°	153.0'	6,000	154.0'	5,700	142.0'	7,900	142.0'	7,700	130.0'	9,500	131.0'	9,300	84.6'	26,000	85.3'	25,800
45°	160.0'	5,100	160.0'	4,900	148.0'	6,800	148.0'	6,600	136.0'	8,400	136.0'	7,900	88.9'	23,800	89.2'	23,600
43°	164.0'	4,400	164.0'	4,200	152.0'	6,200	152.0'	6,000	140.0'	7,500	140.0'	7,300	91.5'	22,500	91.9'	22,300
40°	170.0'	3,700	170.0'	3,500	158.0'	5,300	158.0'	5,100	145.0'	6,600	145.0'	6,400	95.1'	20,700	95.8'	20,500
38°	173.0'	3,300	-	-	161.0'	4,900	-	-	148.0'	6,000	-	-	97.8'	19,600	-	-
35°	178.0'	2,600	-	-	166.0'	4,200	-	-	153.0'	5,300	-	-	101.0'	18,300	-	-
33°	181.0'	2,200	-	-	169.0'	3,700	-	-	156.0'	4,900	-	-	103.0'	17,600	-	-
30°	186.0'	1,800	-	-	173.0'	3,300	-	-	160.0'	4,200	-	-	106.0'	16,800	-	-
28°	-	-	-	-	176.0'	3,100	-	-	162.0'	4,000	-	-	108.0'	16,100	-	-
25°	-	-	-	-	179.0'	2,600	-	-	165.0'	3,500	-	-	110.0'	15,400	-	-
20°	-	-	-	-	184.0'	2,200	-	-	170.0'	3,100	-	-	114.0'	14,300	-	-
	2		2		2		2		2		2		4		4	

1) Loaded boom angle (°)

2) Rated lifting capacity in pounds

Notes to Lifting Capacity

GENERAL

1. RATED LIFTING CAPACITIES apply only to the machine as originally manufactured and normally equipped by TADANO LTD. Modifications to the machine or use of optional equipment other than that specified can result in a reduction of capacity.
2. Hydraulic cranes can be hazardous if improperly operated or maintained. Operation and maintenance of this machine must be in compliance with information in the operation and maintenance manual supplied with the crane. If this manual is missing, order a replacement through the distributor.
3. The operator and other personnel associated with this machine shall fully acquaint themselves with the latest applicable ASME B30.5 safety standards for cranes as mentioned in OSHA CFR29 part 1926.

SET UP

1. Rated lifting capacities on the load chart are the maximum allowable crane capacities, are based on the machine standing level on firm supporting surface under ideal job conditions. Depending on the nature of the supporting surface, it may be necessary to have structural supports under the outrigger floats or tires to spread the loads to a larger surface.
2. For outrigger operation, outriggers shall be properly extended with tires free of supporting surface before operating crane.

OPERATION

1. Rated lifting capacities have been tested to and meet minimum requirements of SAE J1063-Cantilevered Boom Crane Structures Method of Test.
2. Rated lifting capacities do not exceed 85% of the tipping load on outriggers fully extended as determined by SAE J765-Crane Stability Test Code.
Rated lifting capacities for partially extended outriggers are determined from the formula, $\text{rated lifting capacities} = (\text{tipping load} - 0.1 \times \text{tip reaction}) / 1.25$.
3. Rated lifting capacities above thick lines in the chart are based on crane strength and those below, on its stability. They are based on actual load radius increased by boom deflection.
4. The weight of handling device such as hook blocks, slings, etc., must be considered as part of the load and must be deducted from the lifting capacities.
5. Rated lifting capacities are based on freely suspended loads and make no allowance for such factors as the effect of wind, sudden stopping of loads, supporting surface conditions, inflation of tires, operating speeds, side loads, etc. Side pull on the boom or jib is extremely dangerous. Such action can damage the boom, jib or slewing mechanism, and lead to overturning the crane.
6. Rated lifting capacities do not account for wind on lifted load or boom. We recommend against working under the conditions that the load is out of control due to a strong wind. During boom lift, consider that the rated lifting capacity is reduced by 50% when the wind speed is 20 mph to 27 mph; reduced by 70% when the wind speed is 27 mph to 31 mph. If the wind speed is 31 mph or over, stop operation. During jib lift, stop operation if the wind speed is 20 mph or over.
7. Rated lifting capacities at load radius shall not be exceeded. Do not tip the crane to determine allowable loads.
8. Do not operate at boom lengths, radii, or boom angle, where no capacities are shown. Crane may overturn without any load on the hook.
9. When boom length is between values listed, refer to the rated lifting capacities of the next longer and next shorter booms for the same radius. The lesser of the two rated lifting capacities shall be used.
10. When making lifts at a load radius not shown, use the next longer radius to determine allowable capacity.
11. Load per line should not exceed 15,900 lb for main winch and auxiliary winch.
12. Check the actual number of parts of line with LOAD MOMENT INDICATOR (AML-C) before operation. Maximum lifting capacity is restricted by the number of parts of line of LOAD MOMENT INDICATOR (AML-C). Limited capacity is as determined from the formula, single line pull for main winch 15,900 lb x number of parts of line.
13. The boom angle before loading should be greater to account for deflection. For rated lifting capacities, the loaded boom angle and the load radius is for reference only.
14. Do not operate extension or retraction of the boom with loads.
15. For lifting capacity of single top, deduct the weight of the load handling equipment from the rated lifting capacity of the boom.
For the lifting capacity of single top, the net capacity shall not exceed 15,900 lb including main boom hook mass attached to the boom.
16. When the base jib or top jib or both jibs are removed, set the jib state switch to the REMOVED position.
17. When erecting and stowing jib, be sure to retain it by hand or by other means to prevent its free movement.
18. Use "ANTI-TWO-BLOCK DEVICE" disable switch when erecting and stowing jib and when stowing hook block.
While the switch is pushed, the winch does not stop, even when overwind condition occurs.
19. For selected boom length or less with jib, rated lifting capacities are determined by loaded boom angle only in the column headed "selected boom + jib".

Notes to Lifting Capacity

20. The boom extending operation and lowering operation are prohibited during lifting a load with multiple line lift. When lifting a load by using jib (aux. winch) and boom (main winch) simultaneously, do the following:
 - Enter the operation status as jib operation, not as boom operation.
 - Before starting operation, make sure that the mass of a load is within the rated lifting capacity for the jib. (The AML display indicates inaccurate working radius and actual load values during multiple line lift.)
 When lifting a load by using single top (aux. winch) and boom (main winch) simultaneously, do the following:
 - Enter the operation status as single top operation, not as boom operation.
 - Before starting operation, make sure that the mass of a load is within the rated lifting capacity for the single top. (The AML display indicates inaccurate working radius and actual load values during multiple line lift.)
21. Outriggers shall be extended 26' 10-7/8" spread when installing or removing removable counterweight.

DEFINITIONS

1. Load radius: Horizontal distance from a projection of the axis of rotation to supporting surface before loading to the center of the vertical hoist line or tackle with load applied.
2. Loaded boom angle: The angle between the boom base section and the horizontal, after lifting the rated lifting capacity at the load radius.
3. Working area: Area measured in a circular arc about the centerline of rotation.
4. Freely suspended load: Load hanging free with no direct external force applied except by the hoist line.
5. Side load: Horizontal side force applied to the lifted load either on the ground or in the air.

Warning and Operating Instructions Notes for on Rubber Lifting Capacities

1. Rated lifting capacities on-rubber do not exceed 75% of tipping loads as determined by SAE J765-Crane Stability Test Code.
2. On rubber lifting is only permitted without counterweight and stationary. Creep operation is prohibited. Rated lifting capacities shown in the chart are based on the condition that crane is set on firm level surfaces with suspension lock applied. Those above thick lines are based on tire capacity and those below, on crane stability. They are based on actual load radius increased by tire deformation and boom deflection.
3. If the suspension lock cylinders contain air, the axle will not be locked completely and rated lifting capacities may not be obtainable. Bleed the cylinders according to the operation safety and maintenance manual.
4. Rated lifting capacities are based on proper tire inflation, capacity and condition. Damaged tires are hazardous to safe operation of crane.
5. Tires shall be inflated to correct air pressure. Tires: 26.5R25☆☆ – air pressure: 94 psi.

6. Over front operation shall be performed within 10 degrees in front of chassis.

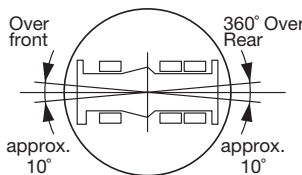

7. On rubber lifting with "jib" is not permitted. Maximum permissible boom length is 71.6'.
8. When making lift on rubber stationary, set parking brake.
9. The mass of the hook (2,381 lb for 110 ton capacity, 661 lb for 7.9 ton capacity), slings and all similarly used load handling devices must be considered as part of the load and must be deducted from the lifting capacities.
10. For rated lifting capacity of single top, reduce the rated lifting capacities of relevant boom according to a weight reductions for auxiliary load handling equipment. Capacities of single top shall not exceed 15,900 lb including main hook.
11. The lifting capacity data stowed in the LOAD MOMENT INDICATOR (AML-C) is based on the standard number of parts of line listed in the chart. Standard number of parts of line for on rubber operation should be according to the following table.

Boom length in feet	42.8' to 71.6'
Number of parts of line	4

Notes for Load Moment Indicator (AML-C)

1. Set AML select keys in accordance with the actually operating crane conditions and don't fail to make sure, before crane operation, that the displays on front panel are correct.
2. When operating crane on outriggers:
 - Set "P.T.O." switch to "ON".
 - Press the outrigger state select key to register for the outrigger operation. If the display agrees with the actual state, press the set key to register. After the completion of the registration, the pop-up window closes.
 - Press the lift state select key to register the lift state to be used (single top / jib / boom).
 - Each time the lift state select key is pressed, the display changes. If the display agrees with the actual state, press the set key to register. After the completion of the registration, the pop-up window closes.
 - When erecting and stowing jib, select the status of jib set (jib lift indicator symbol flickers).
3. When operating crane on rubber:
 - Set "P.T.O." switch to "ON".
 - Press the outrigger state select key to register for the on rubber operation. Each time the outrigger state select key is pressed, the display changes. Select the stationary operation, the on rubber state indicative symbol flickers.
 - Press the lift state select key to register the lift state.

However, pay attention to the following.

For stationary operation.

 - The front and rear capacities are attainable only when the over front or rear position. The front capacities are attainable only when the over front position symbol comes on. When the boom is more than 2 degrees from centered over front of chassis, 360° capacities are in effect.
 - When a load is lifted in the front or rear position and then swung to the side area, make sure the value of the LOAD MOMENT INDICATOR (AML-C) is below the 360° lifting capacity.
4. This machine is equipped with an automatic slewing stop device (for the details, see operation and maintenance manual). But, operate very carefully because the automatic slewing stop does not work in the following case.
 - During on-rubber operation.
 - When the "P.T.O." switch is set to "OVERRIDE" and the "OVERRIDE" key switch outside the cab is on.
5. During crane operation, make sure that the displays on front panel are in accordance with actual operating conditions.
6. The displayed values of LOAD MOMENT INDICATOR (AML-C) are based on freely suspended loads and make no allowance for such factors as the effect of wind, sudden stopping of loads, supporting surface conditions, inflation of tire, operating speed, side loads, etc. For safe operation, it is recommended when extending and lowering boom or slewing, lifting loads shall be appropriately reduced.
7. LOAD MOMENT INDICATOR (AML-C) is intended as an aid to the operator. Under no condition should it be relied upon to replace use of capacity charts and operating instruction. Sole reliance upon LOAD MOMENT INDICATOR (AML-C) aids in place of good operating practice can cause an accident. The operator must exercise caution to assure safety.

TECHNICAL DESCRIPTION

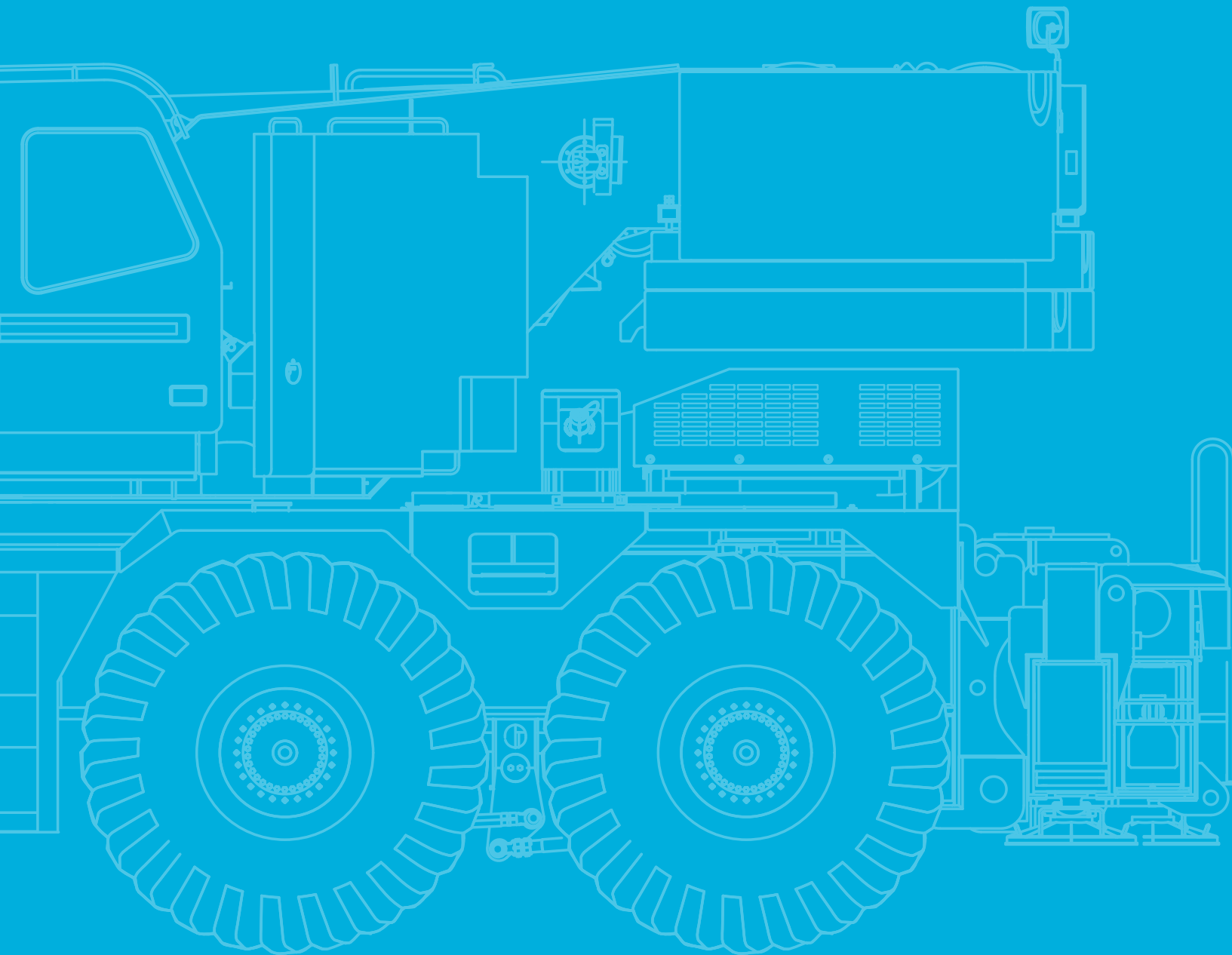

Technical Description

Crane specifications

Boom	6 sections boom of round box construction with 7 sheaves at boom head, extended by single telescoping cylinder. 2 easily removable wire rope guards, rope dead end provided on both sides of boom head. Boom telescope sections are supported by wear pads both vertically and horizontally. Fully retracted length: 42.8' · Fully extended length: 200.1' · Extension speed: 157.3' in 450 s · Sheave root diameter: 15-3/4"
Boom elevation	By a double acting hydraulic cylinder with holding valve. Boom angle indicator. Automatic speed reduction and slow stop function. Boom angle: -1.5° - 81.5° · Boom raising speed: 20° to 60° in 28 s.
Jib	2 stage bi-fold lattice type, offset angle (5° - 40°) by tilt cylinder. Single sheave at the head of both jib sections. Stowed alongside base boom section. Assistant cylinders for mounting and stowing, controlled at right side of superstructure. Self stowing jib mounting pins. Length: 33.8', 59.1' · Offset: 5° - 40° · Sheave root diameter: 17-5/16"
Insert jib (option)	Insert lattice jib can be used for reaching higher place. Length: 23.0' (1 piece), 45.9' (2 pieces).
Short jib (option)	2 sheaves, heavy lifting jib can be used for lifting heavy load in tight spaces. Length: 11.8' · Offset: 20°, 40° · Sheave root diameter: 16-1/2"
Auxiliary lifting sheave (single top)	Single sheave, mounted to main boom head for single line work (stowable). Root diameter: 17-5/16"
Anti-two block device	Pendant type over-winding cut out device with audio-visual (FAILURE lamp/BUZZER) warning system.
Slewing	Hydraulic axial piston motor driven through planetary slewing speed reducer. Continuous 360° full circle slewing on ball bearing turn table at 1.3 min ⁻¹ {rpm}. Equipped with manually locked/released slewing brake. A 360° positive swing lock manually engaged in cab. Twin slewing system: Free slewing or lock slewing controlled by selector switch on front console. Slewing speed: 1.3 min ⁻¹ {rpm}.
Counterweight	Standard weight: 40,100 lb · Extra weight right (option): 12,250 lb · Extra weight left (option): 12,250 lb.
Winch	<p>MAIN WINCH: Variable speed type with grooved drum driven by hydraulic axial piston motor through speed reducer. Power load lowering and raising. Equipped with automatic brake (neutral brake) and counterbalance valve. Controlled independently of auxiliary winch. Equipped with cable follower and drum rotation indicator.</p> <p>MAIN DRUM: Root diameter x wide: 15" x 29-1/4". Wire rope diameter x length: 3/4" x 1050'. Drum capacity: 1293', 7 layers. Maximum single line pull (1st layer): 21,800 lb. Maximum permissible linepull wire strength: 15,900 lb.</p> <p>AUXILIARY WINCH: Variable speed type with grooved drum driven by hydraulic axial piston motor through speed reducer. Power load lowering and raising. Equipped with automatic brake (neutral brake) and counterbalance valve. Controlled independently of main winch. Equipped with cable follower and drum rotation indicator.</p> <p>AUXILIARY DRUM: Root diameter x wide: 15" x 29-1/4". Wire rope diameter x length: 3/4" x 738'. Drum capacity: 1293', 7 layers. Maximum single line pull (1st layer): 21,800 lb. Maximum permissible linepull wire strength: 15,900 lb.</p> <p>WIRE ROPE: Non-rotating 3/4" x 35 class. Breaking strength 79,400 lb.</p>
Hook blocks	110 ton: 7 sheaves with hook block and safety latch. 50 ton (option): 3 sheaves with hook block and safety latch. 7.9 ton: Weighted hook with swivel and safety latch.
Hydraulic system	<p>PUMPS: 2 variable piston pumps for crane functions. Tandem gear pump for steering, swing and optional equipment. Powered by carrier engine. Pump disconnect for crane is engaged/disengaged by rotary switch from operator's cab.</p> <p>CONTROL VALVES: Multiple valves actuated by pilot pressure with integral pressure relief valves.</p> <p>RESERVOIR: 202 gallons capacity. External sight level gauge.</p> <p>FILTRATION: BETA10 = 10 return filter, full flow with bypass protection, located inside of hydraulic reservoir. Accessible for easy replacement.</p> <p>OIL COOLER: Air cooled fan type.</p>
Cab and controls	Both crane and drive operations can be performed from one cab mounted on rotating superstructure. 15° tilt, left side, 1 man type, steel construction with sliding door access and safety glass windows opening at side. Door window is powered control. Windshield glass window and roof glass window are shatter-resistant. Tilt-telescoping steering wheel. Adjustable control lever stands for swing, boom elevating, boom telescoping, auxiliary winch and main winch. Control lever stands can change neutral positions and tilt for easy access to cab. 3 way adjustable operator's seat with high back, headrest and armrest. Engine throttle knob. Foot operated controls: boom elevating boom telescoping, service brake and engine throttle. Hot water cab heater and air conditioning. Dash-mounted engine start/stop, monitor lamps, cigarette lighter, drive selector switch, parking brake switch, steering mode select switch, power window switch, pump engaged/disengaged switch, swing brake switch, telescoping /auxiliary winch select switch, outrigger controls, free swing/lock swing selector switch, eco mode switch, high speed winch (main/aux.) switch and ashtray. Instruments: Torque converter oil temperature, engine water temperature, air pressure, fuel, speedometer, tachometer, hour meter and odometer /tripmeter. Hydraulic oil pressure is monitored and displayed on the AML-C display panel.

Technical Description

Crane specifications

Tadano electronic LOAD MOMENT INDICATOR system (AML-C) including:
Control lever lockout function with audible and visual pre-warning. Boom position indicator. Outrigger state indicator. Boom angle / boom length / jib offset angle / jib length / load radius / rated lifting capacities / actual loads read out. Ratio of actual load moment to rated load moment indication. Automatic speed reduction and slow stop function on boom elevation and slewing. Working condition register switch. Load radius / boom angle / tip height / slewing range preset function. External warning lamp. Tare function. Fuel consumption monitor. Main winch / auxiliary winch select. Drum rotation indicator (audible and visible type) main and auxiliary winch.

TADANO AML-C monitors outrigger extended length and automatically programs the corresponding "RATED LIFTING CAPACITIES" table.

Operator's right hand console includes transmission gear selector and sight level bubble. Upper console includes working light switch, roof washer and wiper switch emergency outrigger set up key switch, jib equipped/removed select switch, eco mode switch, high speed winch (main/aux.) switch, cab tilt switch. Slewing lock lever.

NOTE: Each crane motion speed is based on unladen conditions.

Carrier specifications

Type	Rear engine, left hand steering, driving axle 2-way selected type by manual switch, 6x2 - 1st drive, 6 x 4 - 1st and 3rd drive.
Frame	High tensile steel, all welded mono-box construction.
Engine	Model: Cummins QSB6.7 EPA Tier4 Final · Type: Direct injection diesel · No. of cylinders: 6 · Combustion: 4 cycle, turbo charged and after cooled · Bore x stroke: 4.212 in. x 4.882 in. · Displacement: 409 cu. in liters · Air inlet heater: 24 volt preheat · Air cleaner: Dry type, replaceable element · Oil filter: Full flow with replaceable element · Fuel filter: Full flow with replaceable element · Fuel tank: 79.2 gallons, right side of carrier · Cooling: Liquid pressurized, recirculating by-pass · Radiator: Fin and tube core, thermostat controlled · Fan: Suction type, 9-blade, 28 in. diameter · Starting: 24 volt · Charging: 24 volt system, negative ground · Battery: 2-120 amp. hour · Compressor, air: 17.0 cfm@ 2,400 rpm · Output, max.: Gross 270 HP (201 kW)@2,000 rpm · Torque, max.: 730 ft-lb (990 Nm)@ 1,500 rpm · Capacity: Cooling water 2.7 gallons, lubrication 4.0 gallons, fuel 79.2 gallons, DEF/AdBlue 10.0 gallons.
Transmission	Electronically controlled full automatic transmission. Torque converter driving full powershift with driving axle selector. 5 forward and 2 reverse speeds, constant mesh. 2 speeds - high range - 2 wheel drive; 4 wheel drive. 3 speeds - low range - 4 wheel drive.
Travel speed	9.3 mph with counterweight. 2.5 mph without counterweight.
Gradeability	44% (with counterweight 64,600 lb), 52% (with counterweight 40,100 lb), 57% machine should be operated within the limit of engine crankcase design (30°: Cummins B6.7 EPA Tier4 Final).
Axle	1st: Full floating type, steering and driving axle with planetary reduction and open differential. 2nd: Steering and not driving axle. 3rd: Full floating type, steering and driving axle with planetary reduction and open differential.
Steering	Hydraulic power steering controlled by steering wheel. Four steering modes available: 2 wheel front, 4 wheel rear, 6 wheel coordinated and 6 wheel crab.
Suspension	1st: Rigid mounted to frame. 2nd and 3rd: "Hydro-pneumatic suspension cylinders" with levering adjustment and oscillation.
Brake systems	Service: Air over hydraulic disc brakes on all 6 wheels. Parking/Emergency: Spring applied-air released brake acting on input shaft of 1st and 3rd axle. Auxiliary: Electro-pneumatic operated exhaust brake.
Tires	26.5R25☆☆ - air pressure: 94 psi.
Outriggers	Four hydraulic, beam and jack outriggers. Vertical jack cylinders equipped with integral holding valve. Each outrigger beam and jack is controlled independently from cab. Beams extend to 26' 10-7/8" center-line and retract to within 10' 10-1/2" overall width with floats. Outrigger boxes are self-removable for ease of transportation. Outrigger jack floats are attached thus eliminating the need of manually attaching and detaching them. Controls and sight bubble located in superstructure cab. Four outrigger extension lengths are provided with corresponding "RATED LIFTING CAPACITIES" for crane duty in confined areas. Min. extension: 9' 9-3/4" center to center Mid. extension: 18' 1/2" center to center Mid. extension: 23' 11-3/8" center to center Max. extension: 26' 10-7/8" center to center Float size (diameter): 1' 10-1/2"

Technical Description

Standard equipment

Six section extended boom by single telescoping cylinder	42.8' - 200.1'
Bi-fold lattice jib	33.8' or 59.1'; offset angle (5°-40°) by tilt cylinder.
Quick reeving type bi-fold jib	
Anti-two block device	Overwind cutout.
Mirror	For main and auxiliary winch.
Work lights	
Variable speed main winch	With grooved drum, cable follower and 1050' of 3/4" cable.
Variable speed auxiliary winch	With grooved drum, cable follower and 738' of 3/4" cable.
Drum rotation indicator	Audible, visible and thumper type - main and auxiliary winch.
Auxiliary lifting sheave	Single top, stowable.
2-speed winch	
Tadano twin slewing system and 360° positive slewing lock	
Positive control	
Hydraulic oil cooler	
15° tilt cab	
3 way adjustable cloth seat	With armrests, high back and seat belt.
Tilt-telescoping steering wheel	
Tinted safety glass and sun visor	
Front windshield wiper and washer	
Roof window wiper and washer	
Power window	Cab door.
Cigarette lighter and ashtray	
Cab floor mat	
Pump disconnect in operator's cab	
Air conditioner	Hot water heater and cooler.
Full instrumentation package	
Self centering finger control levers	With pilot control.
Control pedals	For boom elevating and boom telescoping.
Warning device (visual)	Low oil pressure / high water temperature.
2nd and 3rd steer centering light	
Air cleaner dust indicator	
Tadano electronic load moment indicator system (AML-C)	
Tare function	
Boom angle indicator	
Outrigger extension length detector	
Electronic crane monitoring system	
Rear view mirrors	Right and left side.
Fenders	
Air dryer	
Complete highway light package	

Technical Description

Standard equipment

Towing hooks	Front and rear.
Hook block tie down	Front bumper.
Weighted hook storage compartment	
Halogen head lamp	
Self-removable outrigger boxes	
Independently controlled outriggers	
Four outrigger extension positions	
Self-storing outrigger pads	
Electronic controlled automatic transmission driven by torque converter	
Drive / steer	6 x 4 x 6.
Axles	1st axle: open differential. 3rd axle: open differential
Automatic rear axle oscillation lockout system	
Tires	26.5R25☆☆ tires.
Disc brakes	
Water separator with filter	High filtration.
Back-up alarm	
24 volt electric system	
Tool storage compartment	
Tire inflation kit	
Engine	Cummins QS 6.7 turbo charged after cooled engine (270 HP) with exhaust brake.
Engine over-run alarm	
Lifting eyes	
Telematics	Machine data logging and monitoring system with HELLO-NET via internet (availability depends on countries).
Fuel consumption monitor	
Eco mode system	
Self-removable counterweight	
Hook	110 ton - 7 sheaves with hook block and safety latch. 7.9 ton - Weighted hook with swivel and safety latch.

Optional equipment

Additional weight	24,500 lb.
Removable boom system	
Working lamp	With remot controller.
Boom and jib mounted aircraft warning light	
Wind speed indicator	
Emergency steering system	
Over-unwinding prevention	
Insert jib	
Short jib	
Hook block	50 ton - 3 sheaves with hook block and safety latch.

tac.sales@tadano.com
www.tadanoamericas.com

Tadano PanAmerican Operations
4242 W Greens Road, Houston, TX 77066
Phone: +1 (281) 869-0030



Lifting your dreams

