

Manitex



TC400-TC450



















40-Ton (36,3 mt) 45-Ton (40,8 mt) TELESCOPIC CRANE
TC400-TC450 SERIES PRODUCT GUIDE

















CONTENTS

Crane Features	4
TC450 Chassis Data	5
TC400 Chassis Data	7
Reeving Diagrams	9
Outriggers.....	10
TC45142 Load Chart: Main Boom	12
TC45142 Boom Diagram	13
TC40142 Load Chart: Main Boom	14
TC40142 Boom Diagram	15
TC45127 Load Chart: Main Boom	16
TC45127 Boom Diagram	17
TC40127 Load Chart: Main Boom	18
TC40127 Boom Diagram	19
Area of Operation.....	20
LMI Codes	20
Warning, Information & Definitions	21
Technical Descriptions	22
Options	23

Effective Date: September 1, 2015
 This document is non-contractual. This document is supplied for reference use only. We are continuously making improvements and reserve the right to change without notice or obligation. The photographs, and /or images in this document are for illustrative purposes only and may include optional equipment and accessories and may not include all standard equipment. Refer to the appropriate Operator's Manual and Load Charts for instructions on the proper use of this equipment to determine allowable crane lifting capacities, assembly and operating procedures. Failure to follow the appropriate operator's manual or load chart(s) when using our equipment or to otherwise act irresponsibly may result in serious injury or death. The warranty applicable to our equipment is the standard written warranty applicable to the particular product and sale. Manitex makes no other warranty, expressed or implied. Products and services listed may be trademarks, service marks or trade-names of Manitex International and /or its subsidiaries in the USA and other countries. All rights are reserved. Manitex® is a registered trademark of Manitex International, Inc. in the USA and many other countries. Copyright 2017 Manitex Inc. Manitex Inc, Georgetown Texas, 78626

KEY

	Operator aids
	Cab
	Heating / Air conditioning
	Controls
	Hoist speed
	1 - Main hoist 2 - Auxiliary winch 3 - Recovery winch
	Rope length
	Rope - standard/optional
	Rope diameter
	Permissible line pull
	Maximum line pull
	Slewing / Allowable slewing range
	Slewing gears
	Slewing brake
	Outriggers / Lifting on outriggers
	2-Person man basket
	Counterweight
	Radio remote control

	Hook block
	Distance from hook to head sheave pin
	Hook and ball
	Hydraulics
	Boom elevation angle
	Max. boom length with extension
	Boom with extension retracted
	Boom angle
	Telescoping mode
	Working radius
	Boom length
	Hydraulic actuated boom
	Full power mechanical synchronized
	Boom head / Hook block dimension
	Main boom with auxiliary head
	Tip height





THE TC400-TC450 SERIES TELESCOPIC CRANES

Versatile. Affordable. User friendly.

The TC400-TC450 series telescopic cranes are built to meet the wide-ranging needs of owner operators who may use it for residential construction one day and bridge work the next. No matter what the task, the 40-45-ton line of telescopic cranes are designed to get you to the job quickly.

With it, you can:

- Travel to and from job sites at highway speed on a commercial chassis
- Set up quickly with radio outrigger controls
- Operate comfortably and with confidence in its tiltable cab

Other features include:

- 45-ton capacity @7 ft. radius
- 40-ton capacity @7 ft. radius
- Optional telescopic jib
- 152' (46,3 m) maximum boom tip height
- Out and down outriggers

NEW COMBINED RADIO REMOTE



RADIO OUTRIGGER CONTROLS

One control to operate the outriggers, winch controls and the boom.

Operate the outriggers remotely, with a clear view of the machine, using radio remote controls.

CAB UPGRADES



All cabs now come equipped with Heat and AC with more air flow. Adjustable cab tilt speed and crane functions. USB ports for quick software updates or phone charging.

More leg space and only one display unit needed for both crane and chassis monitoring.

TELEMATICS



A modem has been added to the crane PLC system to aid troubleshooting machines in the field. Crane software updates can now be uploaded to the machine without having to send a technician to the field! GPS ready for tracking through the Manitex web portal.

OPERATOR AIDS

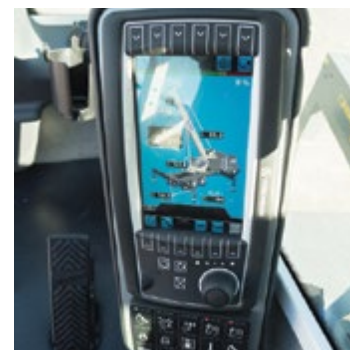

TC400-TC450 with LMI system for crane function cut-offs for overload protection. color graphic display, event recorder, WADS-Work Definition System.

TC450 SERIES CHASSIS DATA

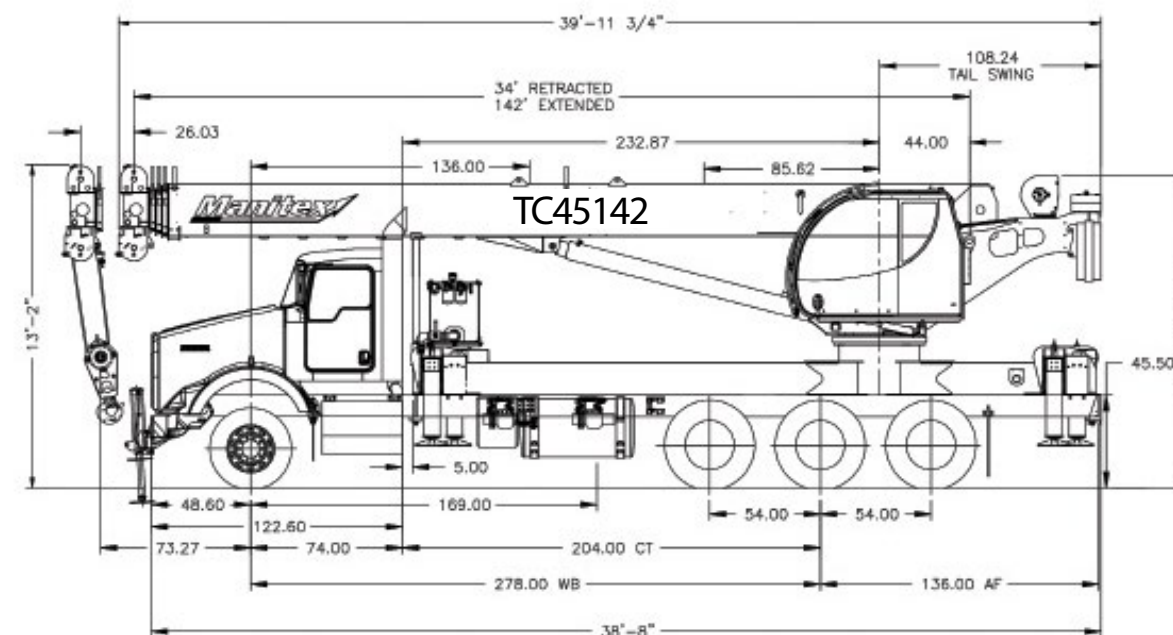

CHASSIS DATA

Model	TC45142
Wheel Base (WB)	278 in. (7,061 mm)
Cab to Tridem (CT)	204 in. (5281.6 mm)
Frame section modulus at 360° area of operation	27.0 in ³ , 110,000 psi, 758,422 kPa
Cab to End of Frame (EOF)	316 in. (8026 mm)
Nominal Frame Width	34 in. (864 mm)

CRANE WEIGHTS

Model	TC45142
Crane with cab	45,550 lb. (18,8847 kg)
Aluminum Platform	621 lb. (282 kg)
Tele Jib	1620 lb. (735 kg)

TRUCK AXLE WEIGHTS

Model	TC45142
Front axle (GW)	20,000 lb. (9,790 kg)
Rear axle	40,000 lb. (19,580 kg)
Tag Axle Rating	12,500 lb. (5669 kg)
Min. truck axle W - Front**	9,000 lb. (4082 kg)
Min. truck axle W - Rear**	9,600 lb. (4354 kg)

** Minimum chassis weight is required to meet 85% stability requirements. Chassis data is general - not for engineering. Some dimensions depend on truck selection. Data published herein is intended as a guide only. Crane operation is subject to machine specific load charts and information.

TC450 SERIES CHASSIS DATA

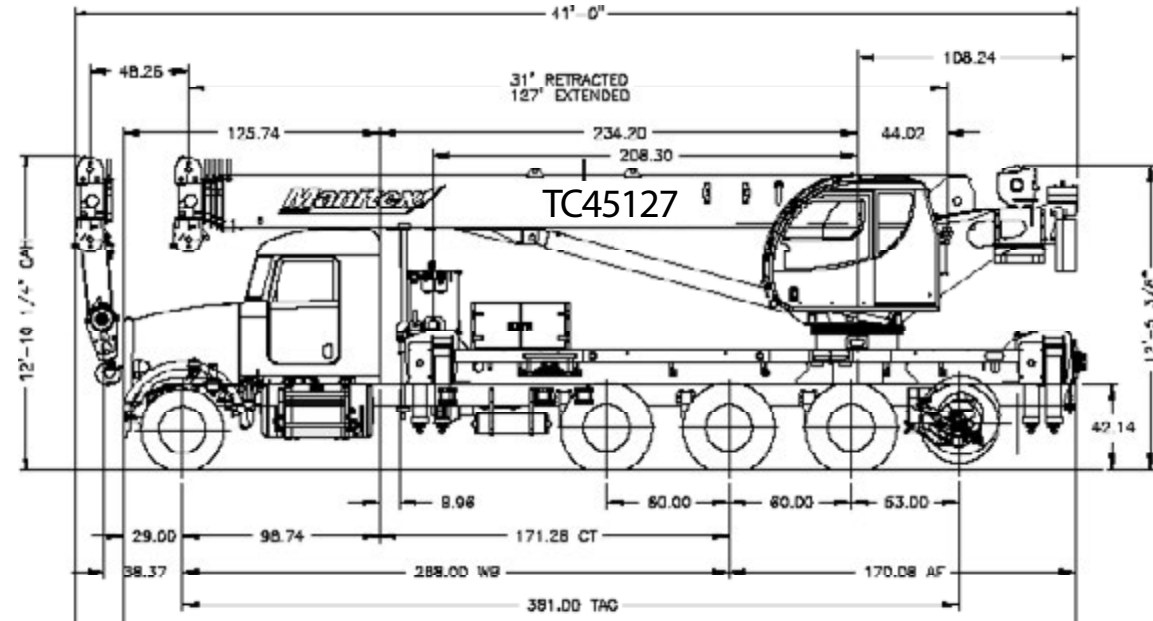

CHASSIS DATA

Model	TC45127
Wheel Base (WB)	268"
Cab to Tandem (CT)	181"
Frame section modulus at 360° area of operation	27.0 in ³ , 110,000 psi, 758,422 kPa
Cab to End of Frame (EOF)	346"
Nominal Frame Width	34"

CRANE WEIGHTS

Model	TC45127
Crane with cab	40,738 lb. (18,479 kg)
Aluminum Platform	621 lb. (282 kg)
Tele Jib	1,620 lb. (735 kg)

TRUCK AXLE WEIGHTS

Model	TC45127
Front axle (GAWR)	20,000 lb. (9,790 kg)
Rear axle (GAWR)	40,000 lb. (19,580 kg)
Tag axle (GAWR)	12,500 lb. (5669 kg)
Min. truck axle W - Front**	9,000 lb. (4082 kg)
Min. truck axle W - Rear**	9,600 lb. (4354 kg)

** Minimum chassis weight is required to meet 85% stability requirements. Chassis data is general - not for engineering. Some dimensions depend on truck selection. Data published herein is intended as a guide only. Crane operation is subject to machine specific load charts and information.

TC400 SERIES CHASSIS DATA

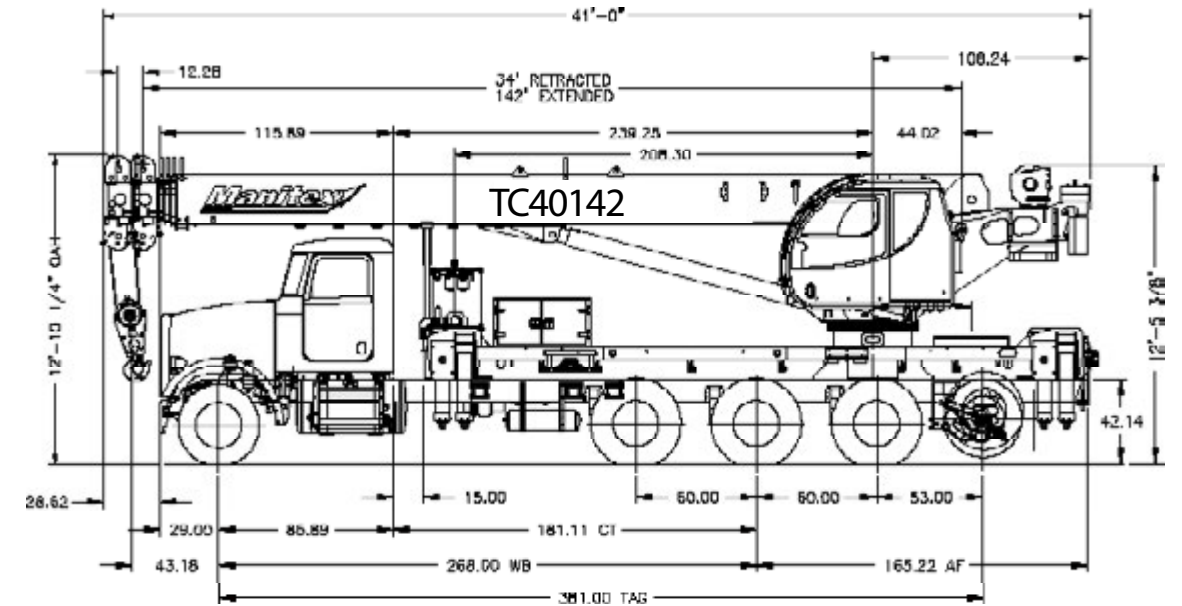

CHASSIS DATA

Model	TC40142
Wheel Base (WB)	268"
Cab to Tandem (CT)	181"
Frame section modulus at 360° area of operation	27.0 in ³ , 110,000 psi, 758,422 kPa
Cab to End of Frame (EOF)	346"
Nominal Frame Width	34"

CRANE WEIGHTS

Model	TC40142
Crane with cab	39,500 lb. (17,917 kg)
Aluminum Platform	621 lb. (282 kg)
Tele Jib	1620 lb. (735 kg)

TRUCK AXLE WEIGHTS

Model	TC40142
Front axle (GAWR)	20,000 lb. (9,790 kg)
Rear axle (GAWR)	40,000 lb. (19,580 kg)
Tag axle (GAWR)	12,500 lb. (5669 kg)
Min. truck axle W - Front**	9,000 lb. (4082 kg)
Min. truck axle W - Rear**	9,600 lb. (4354 kg)

** Minimum chassis weight is required to meet 85% stability requirements. Chassis data is general - not for engineering. Some dimensions depend on truck selection.

TC400 SERIES CHASSIS DATA

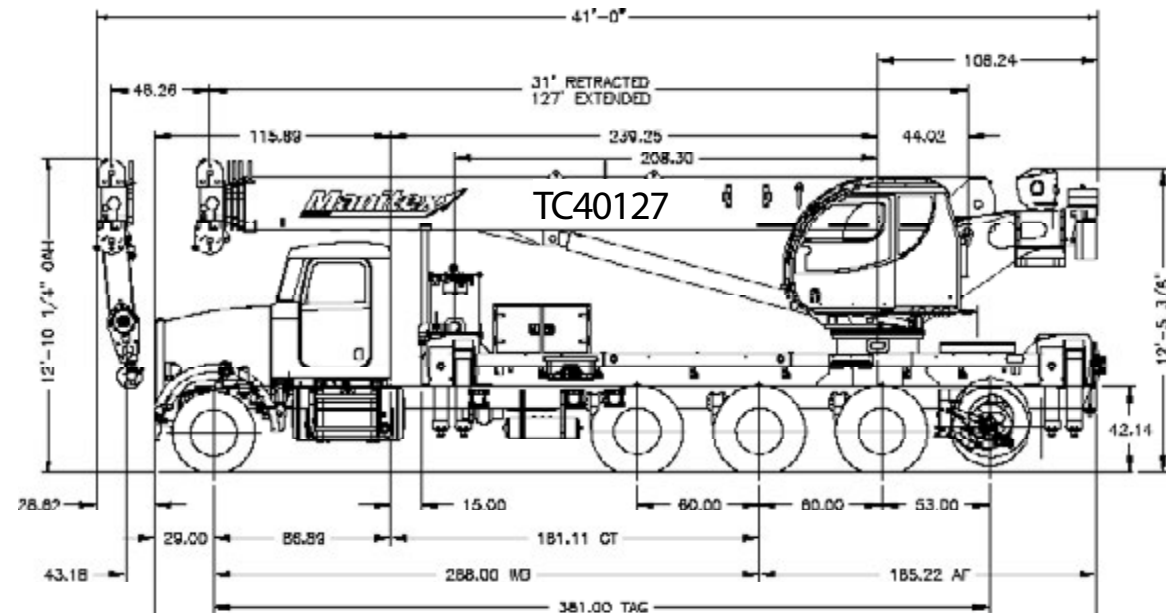

CHASSIS DATA

Model	TC40127
Wheel Base (WB)	268"
Cab to Tandem (CT)	181"
Frame section modulus at 360° area of operation	27.0 in ³ , 110,000 psi, 758,422 kPa
Cab to End of Frame (EOF)	346"
Nominal Frame Width	34"

CRANE WEIGHTS

Model	TC40127
Crane with cab	38,738 lb. (17,592 kg)
Aluminum Platform	621 lb. (282 kg)
Tele Jib	1,620 lb. (735 kg)

TRUCK AXLE WEIGHTS

Model	TC40127
Front axle (GAWR)	20,000 lb. (9,790 kg)
Rear axle (GAWR)	40,000 lb. (19,580 kg)
Tag axle (GAWR)	12,500 lb. (5,669 kg)
Min. truck axle W - Front**	9,000 lb. (4,082 kg)
Min. truck axle W - Rear**	9,600 lb. (4,354 kg)

** Minimum chassis weight is required to meet 85% stability requirements. Chassis data is general - not for engineering. Some dimensions depend on truck selection.

Data published herein is intended as a guide only. Crane operation is subject to machine specific load charts and information.



REEVING DIAGRAMS

TC450

ALLOWABLE LINE PULL									WARNING
1 PART LINE	2 PART LINE	3 PART LINE	4 PART LINE	5 PART LINE	6 PART LINE	7 PART LINE	8 PART LINE	9 PART LINE	
									ANTI-TWO-BLOCK SYSTEM MUST BE IN GOOD OPERATING CONDITION BEFORE OPERATING CRANE. REFER TO THE OWNER'S MANUAL. KEEP AT LEAST 3 WRAPS OF LOAD LINE ON THE DRUM AT ALL TIMES.
9500 LBS	18000 LBS	28500 LBS	38000 LBS	47500 LBS	57000 LBS	68500 LBS	78000 LBS	85500 LBS	
10000 LBS	20000 LBS	30000 LBS	40000 LBS	50000 LBS	60000 LBS	70000 LBS	80000 LBS	90000 LBS	5/8" 6 X 25 IWRC (3.5:1 SF) - 35000 LBS MIN BREAKING STRENGTH

TC400

ALLOWABLE LINE PULL									WARNING
1 PART LINE	2 PART LINE	3 PART LINE	4 PART LINE	5 PART LINE	6 PART LINE	7 PART LINE	8 PART LINE	9 PART LINE	
									ANTI-TWO-BLOCK SYSTEM MUST BE IN GOOD OPERATING CONDITION BEFORE OPERATING CRANE. REFER TO THE OWNER'S MANUAL. KEEP AT LEAST 3 WRAPS OF LOAD LINE ON THE DRUM AT ALL TIMES.
9500 LBS	18000 LBS	28500 LBS	38000 LBS	47500 LBS	57000 LBS	68500 LBS	76000 LBS	80000 LBS	
10000 LBS	20000 LBS	30000 LBS	40000 LBS	50000 LBS	60000 LBS	70000 LBS	80000 LBS	80000 LBS	5/8" 6 X 25 IWRC (3.5:1 SF) - 35000 LBS MIN BREAKING STRENGTH

Deductions from rated loads for load handling devices supplied by Manitex

Auxiliary block	50 lbs. (22.7 kg)
Overhaul ball	See overhaul ball mfg. nameplate
Load blocks	See load block mfg. nameplate
Swing around jib (stowed)	See load chart

WARNING: Lifting off the main boom point while the jib is erected is not intended nor approved.

Data published herein is intended as a guide only. Crane operation is subject to machine specific load charts and information.

OUTRIGGERS

Full Extension

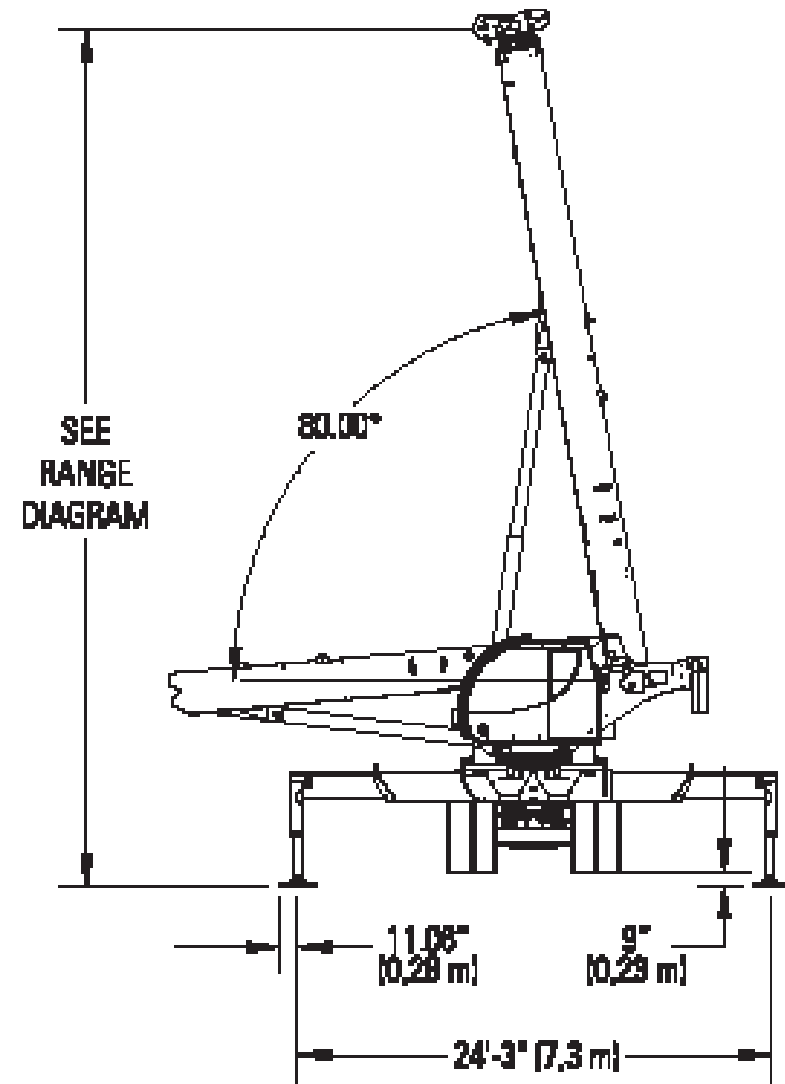

SUBFRAME

- Pedestal sub-frame and stabilizers are mounted to chassis by threaded rods and clamp plates.
- Sub-frame: Torsion resistant, rigid 4-plate design mounted under crane full length of truck frame.
- Rear underride protection: Standard on factory mounted cranes.

ELECTRICAL SYSTEM

- State-of-the-art weather-resistant components throughout.
- Hermetically sealed enclosure includes power in relays and circuit status LEDs.
- 12-24 Volt Capability.
- PLC/CANBUS Technology

Data published herein is intended as a guide only. Crane operation is subject to machine specific load charts and information.



OUTRIGGERS

Intermediate Spread

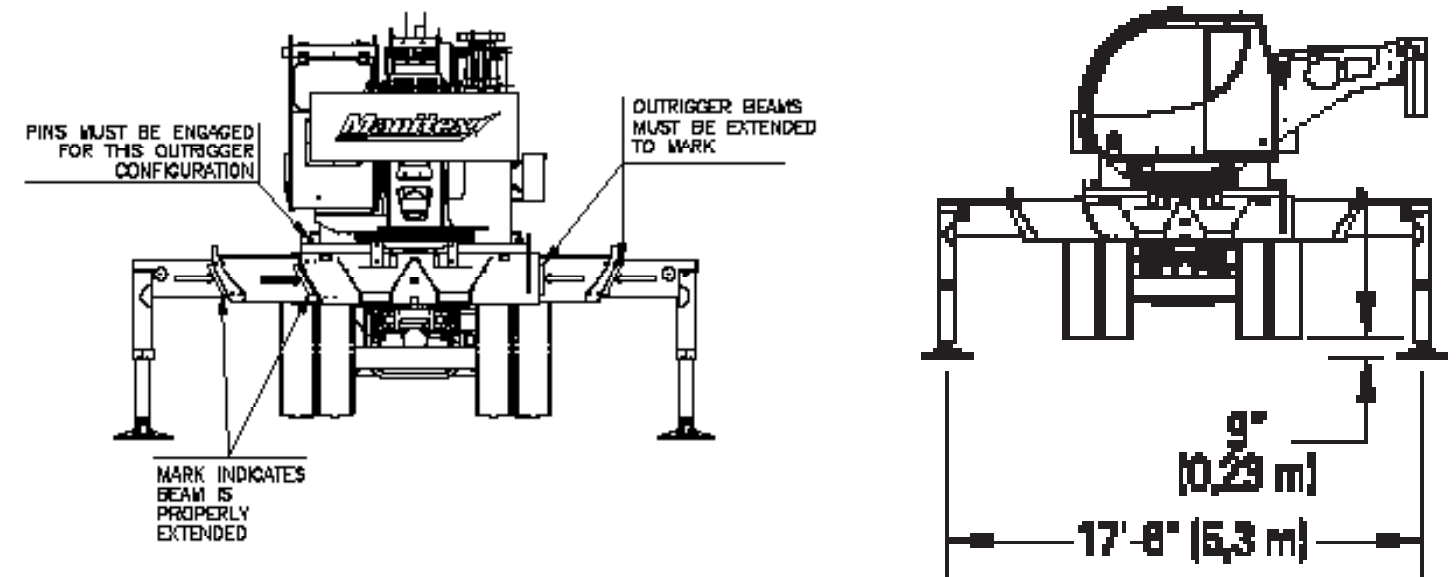

Fully Retracted Spread

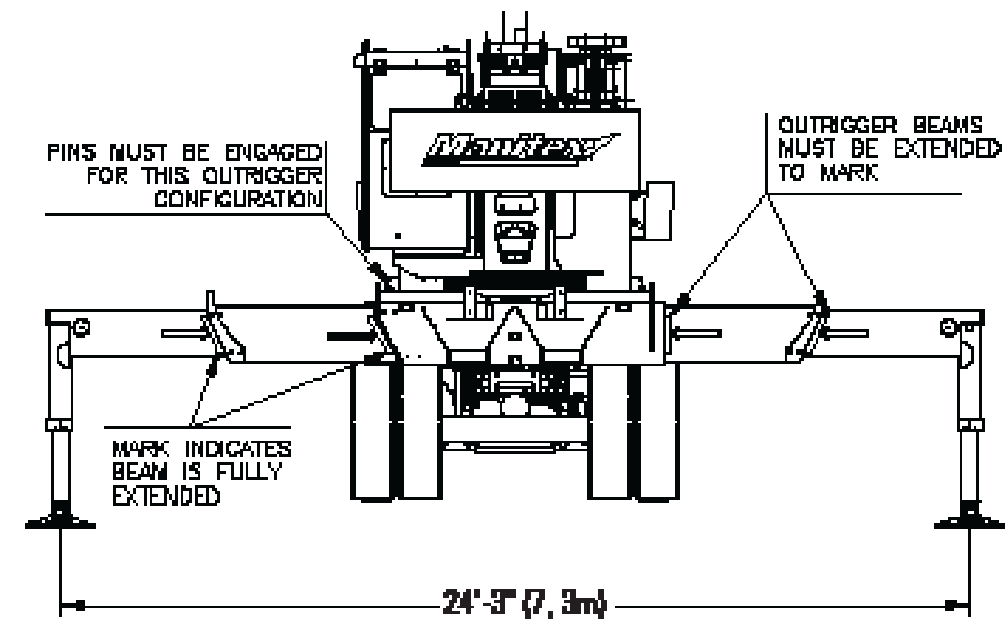

Data published herein is intended as a guide only. Crane operation is subject to machine specific load charts and information.

TC45142 LOAD CHART: Main Boom & Jib

Lifting Capacities 5 section Boom 142 ft. 43,3 m
Full Outrigger Extension



MAIN BOOM RATED LOADS LMI CODES 3																			
Load radius ∠°	34 ft.		47 ft. (A)		61 ft. (B)		74 ft. (C)		88 ft. (D)		101 ft. (E)		115 ft. (F)		128 ft. (G)		142 ft. (H)		Load radius ∠°
	(deg)	Load Capacity (lbs.)	(deg)	Load Capacity (lbs.)	(deg)	Load Capacity (lbs.)	(deg)	Load Capacity (lbs.)	(deg)	Load Capacity (lbs.)	(deg)	Load Capacity (lbs.)	(deg)	Load Capacity (lbs.)	(deg)	Load Capacity (lbs.)	(deg)	Load Capacity (lbs.)	
7	73	90,000																	7
8	71	80,000	77	42,000															8
10	67	70,500	74	42,000	79	42,000													10
12	64	62,100	72	42,000	77	42,000	80	34,060											12
15	58	49,450	68	42,000	74	40,960	78	32,860	80	23,430									15
20	47	35,640	61	36,240	69	36,570	74	30,970	77	21,610	79	16,510							20
25	33	27,160	54	27,810	64	28,140	70	28,310	74	19,730	76	15,160	79	13,500					25
30	9	19,390	46	22,100	58	22,450	65	22,630	70	18,300	74	13,960	77	12,420	79	10,000	80	8,000	30
35			36	17,980	52	18,350	61	18,530	67	17,060	71	12,860	74	11,420	76	9,800	78	7,800	35
40			23	14,840	46	15,250	56	15,440	63	15,570	68	11,860	71	10,540	74	9,400	76	7,600	40
45					39	12,820	51	13,020	59	13,150	64	10,990	69	9,550	72	8,800	74	7,350	45
50					30	10,850	46	11,070	55	11,210	61	10,200	66	8,870	69	8,300	72	7,050	50
55					18	8,870	40	9,170	51	9,340	58	9,430	63	8,260	67	7,900	70	6,800	55
60							33	7,610	47	7,790	54	7,890	60	7,680	64	7,450	68	6,500	60
65							24	6,330	42	6,520	50	6,630	57	6,710	62	6,770	66	6,100	65
70									36	5,480	46	5,590	54	5,670	59	5,720	64	5,700	70
75									30	4,590	42	4,700	51	4,790	56	4,840	61	4,880	75
80									21	3,820	37	3,950	47	4,030	54	4,090	59	4,130	80
85											32	3,300	43	3,380	51	3,440	56	3,480	85
90											25	2,720	39	2,810	47	2,870	54	2,910	90
95											17	2,200	35	2,310	44	2,370	51	2,410	95
100												30	1,870	40	1,930	48	1,970	100	
105												23	1,460	36	1,530	45	1,580	105	
110												12	1,090	32	1,170	42	1,220	110	
115														26	840	38	900	115	
120																		120	
		840 lbs.		560 lbs.		450 lbs.		380 lbs.		330 lbs.		290 lbs.		260 lbs.		230 lbs.		210 lbs.	

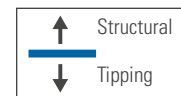

NOTES:

- Loads based on crane on outriggers
- All "on outriggers" loads are based on 85% tipping
- Loads above heavy line are based on structural rating
- Loads below heavy line are based on tipping rating

Data published herein is intended as a guide only. Crane operation is subject to machine specific load charts and information.

JIB LOAD CAPACITIES					
Load radius ∠°	LMI CODE 7		LMI CODE 13		Load radius ∠°
	30.5 ft. Tele Jib (deg)	Load Capacity (lbs.)	55 ft. Tele. Jib (deg)	Load Capacity (lbs.)	
30					30
35	79.0	3,450			35
40	77.2	3,400	79.4	2,500	40
45	76.1	3,350	78.0	2,250	45
50	74.7	3,330	76.7	2,250	50
55	73.2	3,180	75.6	2,250	55
60	71.5	2,920	74.5	2,250	60

65	69.4	2,760	73.1	2,100	65
70	68.0	2,610	72.1	1,970	70
75	66.3	2,470	70.5	1,860	75
80	64.5	2,340	68.7	1,760	80
85	62.9	2,220	67.1	1,670	85
90	61.1	2,110	66.1	1,590	90
95	59.4	2,010	64.6	1,530	95
100	57.4	1,920	62.9	1,460	100
105	54.5	1,550	61.4	1,400	105
110	52.7	1,190	60.2	1,340	110

TC45142 BOOM DIAGRAM

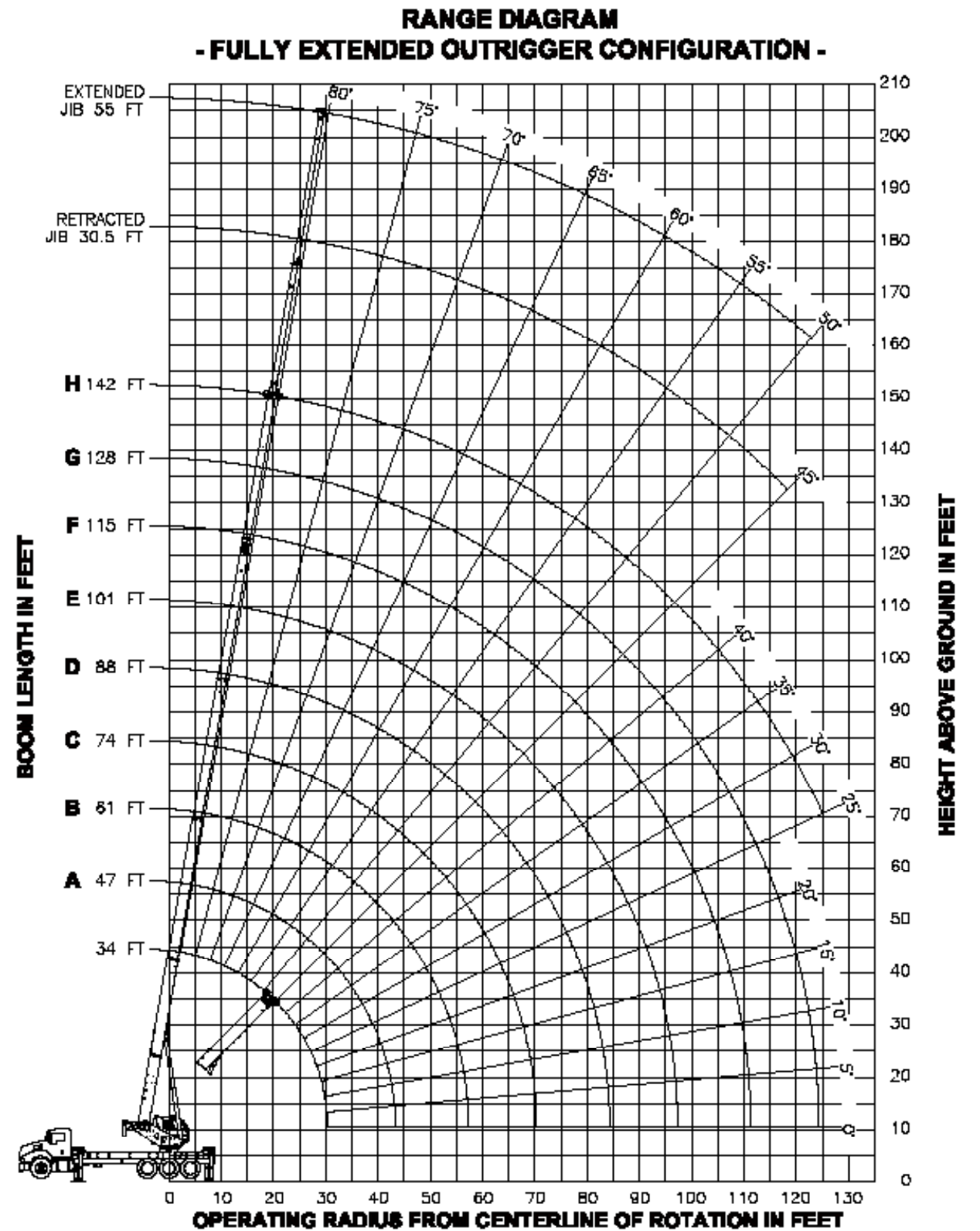

Data published herein is intended as a guide only. Crane operation is subject to machine specific load charts and information.

TC40142 LOAD CHART: Main Boom & Jib

Lifting Capacities 5 section Boom 142 ft. 43,3 m
Full Outrigger Extension



MAIN BOOM RATED LOADS LMI CODES 3																			
Load radius ∠°	34 ft.		47 ft. (A)		61 ft. (B)		74 ft. (C)		88 ft. (D)		101 ft. (E)		115 ft. (F)		128 ft. (G)		142 ft. (H)		Load radius ∠°
	(deg)	Load Capacity (lbs.)	(deg)	Load Capacity (lbs.)	(deg)	Load Capacity (lbs.)	(deg)	Load Capacity (lbs.)	(deg)	Load Capacity (lbs.)	(deg)	Load Capacity (lbs.)	(deg)	Load Capacity (lbs.)	(deg)	Load Capacity (lbs.)	(deg)	Load Capacity (lbs.)	
7	73	80,000																	7
8	71	80,000	77	42,000															8
10	67	70,500	74	42,000	79	42,000													10
12	64	61,000	72	42,000	77	42,000	80	35,700											12
15	58	47,890	68	42,000	74	40,960	78	35,700	80	24,200									15
20	47	34,460	61	35,060	69	35,380	74	30,970	77	24,200	79	17,550							20
25	33	26,210	54	26,850	64	27,180	70	27,360	74	21,730	76	16,210	79	13,650					25
30	9	19,380	46	21,310	58	21,650	65	21,830	70	19,680	74	15,010	77	12,750	79	10,050	80	8,000	30
35			36	17,290	52	17,660	61	17,850	67	17,060	71	13,860	74	11,700	76	9,800	78	7,800	35
40			23	14,240	46	14,640	56	14,840	63	14,970	68	12,810	71	10,920	74	9,400	76	7,600	40
45					39	12,280	51	12,480	59	12,620	64	11,440	69	10,230	72	8,800	74	7,350	45
50					30	10,370	46	10,590	55	10,730	61	10,200	66	9,550	69	8,300	72	7,050	50
55					18	8,470	40	8,770	51	8,940	58	9,050	63	8,260	67	7,900	70	6,800	55
60							33	7,250	47	7,430	54	7,540	60	7,620	64	7,450	68	6,500	60
65							24	5,770	42	5,980	50	6,110	57	6,390	62	6,440	66	6,100	65
70							8	4,630	36	4,890	46	5,020	54	5,110	59	5,170	64	5,220	70
75									30	3,990	42	4,120	51	4,200	56	4,270	61	4,320	75
80									21	3,220	37	3,360	47	3,450	54	3,510	59	3,560	80
85											32	2,710	43	2,810	51	2,870	56	2,910	85
90											25	2,140	39	2,250	47	2,300	54	2,350	90
95											17	1,630	35	1,750	44	1,820	51	1,870	95
100													30	1,320	40	1,390	48	1,440	100
105													23	940	36	1,000	45	1,050	105
110																	42	710	110
115																			115
120																			120
	840 lbs.	560 lbs.	450 lbs.	380 lbs.	330 lbs.	290 lbs.	260 lbs.	230 lbs.	210 lbs.										

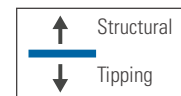

NOTES:

- Loads based on crane on outriggers
- All "on outriggers" loads are based on 85% tipping
- Loads above heavy line are based on structural rating
- Loads below heavy line are based on tipping rating

JIB LOAD CAPACITIES					
Load radius ∠°	LMI CODE 7		LMI CODE 13		Load radius ∠°
	30.5 ft. Tele Jib	55 ft. Tele. Jib	30.5 ft. Tele Jib	55 ft. Tele. Jib	
30					30
35	79.0	3,450			35
40	77.2	3,400	79.4	2,500	40
45	76.1	3,350	78.0	2,250	45
50	74.7	3,330	76.7	2,250	50
55	73.2	3,180	75.6	2,250	55
60	71.5	2,920	74.5	2,250	60

65	69.4	2,760	73.1	2,100	65
70	68.0	2,610	72.1	1,970	70
75	66.3	2,470	70.5	1,860	75
80	64.5	2,340	68.7	1,760	80
85	62.9	2,220	67.1	1,670	85
90	61.1	2,110	66.1	1,590	90
95	59.4	2,010	64.6	1,530	95
100	57.4	1,760	62.9	1,460	100
105	54.5	1,370	61.4	1,400	105
110	52.7	1,020	60.2	1,340	110

Data published herein is intended as a guide only. Crane operation is subject to machine specific load charts and information.

TC40142 BOOM DIAGRAM

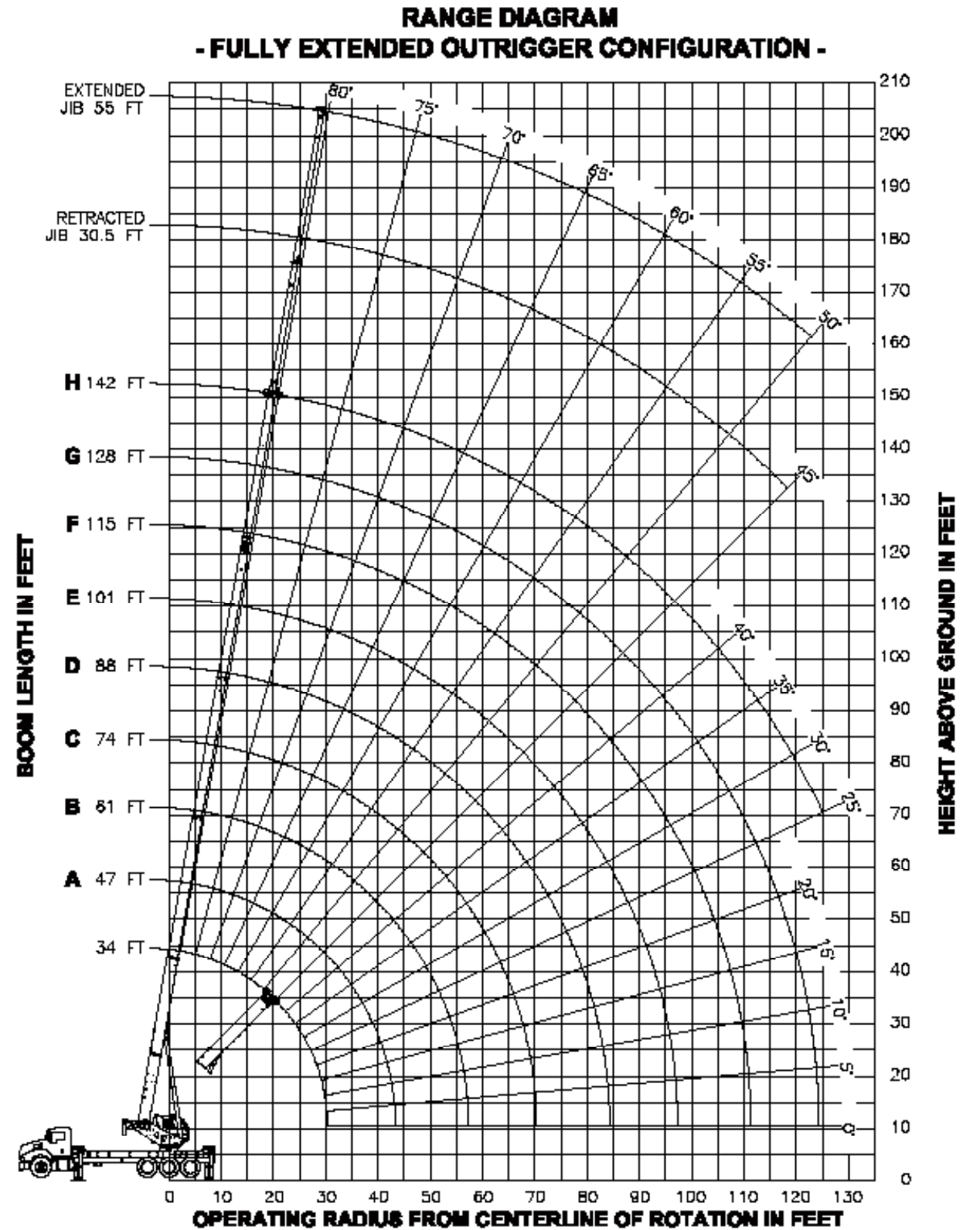

Data published herein is intended as a guide only. Crane operation is subject to machine specific load charts and information.

TC45127 LOAD CHART: Main Boom & Jib

Lifting Capacities 5 section Boom 142 ft. 43,3 m
Full Outrigger Extension



MAIN BOOM RATED LOADS LMI CODES 3																			
Load radius ⤴ °	31 ft.		43 ft. (A)		55 ft. (B)		67 ft. (C)		79 ft. (D)		91 ft. (E)		103 ft. (F)		115 ft. (G)		127 ft. (H)		Load radius ⤴ °
	(deg)	Load Capacity (lbs.)	(deg)	Load Capacity (lbs.)	(deg)	Load Capacity (lbs.)	(deg)	Load Capacity (lbs.)	(deg)	Load Capacity (lbs.)	(deg)	Load Capacity (lbs.)	(deg)	Load Capacity (lbs.)	(deg)	Load Capacity (lbs.)	(deg)	Load Capacity (lbs.)	
7	70	90,000																	7
8	68	80,000																	8
10	64	71,920	72	42,000	76	42,000													10
12	60	61,860	69	42,000	74	42,000													12
15	54	48,860	65	42,000	70	42,000	74	37,500	77	27,900									15
20	41	35,160	57	35,810	65	36,130	70	33,000	73	25,180	75	19,500	77	17,000	78	17,000			20
25	23	26,830	49	27,560	59	27,890	65	28,090	69	22,810	72	17,650	74	15,570	76	13,500	77	10,000	25
30			39	21,970	53	22,330	60	22,520	65	20,940	68	16,250	71	14,420	73	12,420	75	10,000	30
35			26	17,920	46	18,310	55	18,520	61	17,060	65	15,030	68	13,300	70	11,420	72	9,800	35
40					38	15,270	50	15,490	57	15,630	61	13,780	65	12,120	68	10,540	70	9,300	40
45					28	12,880	44	13,120	52	13,260	58	10,990	62	11,050	65	9,830	68	8,800	45
50					13	10,870	37	11,210	47	11,360	54	10,200	59	8,870	62	9,050	65	8,300	50
55							29	9,280	42	9,470	50	9,430	55	8,260	59	8,260	63	7,800	55
60							18	7,740	37	7,950	46	8,070	52	7,680	57	7,680	60	7,450	60
65									30	6,700	41	6,830	48	6,600	53	6,980	57	7,000	65
70									21	5,670	36	5,810	44	5,520	50	5,960	55	6,000	70
75									5	4,760	30	4,940	40	4,600	47	5,090	52	5,140	75
80											23	4,180	36	3,840	43	4,360	49	4,400	80
85											13	3,470	31	3,180	40	3,670	46	3,730	85
90													25	2,610	36	3,010	43	3,140	90
95													17	2,110	31	2,500	39	2,620	95
100															26	2,050	35	2,160	100
105															19	1,650	31	1,750	105
110															9	1,280	27	1,390	110
115																	21	1,060	115
120																	13	760	120
		840 lbs.		610 lbs.		480 lbs.		400 lbs.		340 lbs.		300 lbs.		260 lbs.		240 lbs.		220 lbs.	

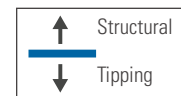

NOTES:

- Loads based on crane on outriggers
- All "on outriggers" loads are based on 85% tipping
- Loads above heavy line are based on structural rating
- Loads below heavy line are based on tipping rating

Data published herein is intended as a guide only. Crane operation is subject to machine specific load charts and information.

JIB LOAD CAPACITIES					
Load radius ⤴ °	LMI CODE 7		LMI CODE 13		Load radius ⤴ °
	30.5 ft. Tele Jib (deg)	Load Capacity (lbs.)	55 ft. Tele. Jib (deg)	Load Capacity (lbs.)	
15					15
20	79.0	3,450			20
25	77.1	3,400			25
30	75.3	3,320	78.9	2,500	30
35	73.4	3,190	77.3	2,500	35
40	71.5	2,910	75.7	2,500	40
45	69.5	2,770	74.1	2,200	45

50	67.6	2,570	72.4	2,010	50
55	65.6	2,420	70.8	1,870	55
60	63.6	2,270	69.1	1,780	60
65	61.6	2,130	67.4	1,680	65
70	59.5	2,010	65.7	1,570	70
75	57.3	1,910	64.0	1,500	75
80	55.2	1,630	62.2	1,430	80
85	52.9	1,230	60.4	1,350	85
90			58.6	1,250	90
95					95

TC45127 BOOM DIAGRAM

RANGE DIAGRAM
- FULLY EXTENDED OUTRIGGER CONFIGURATION -

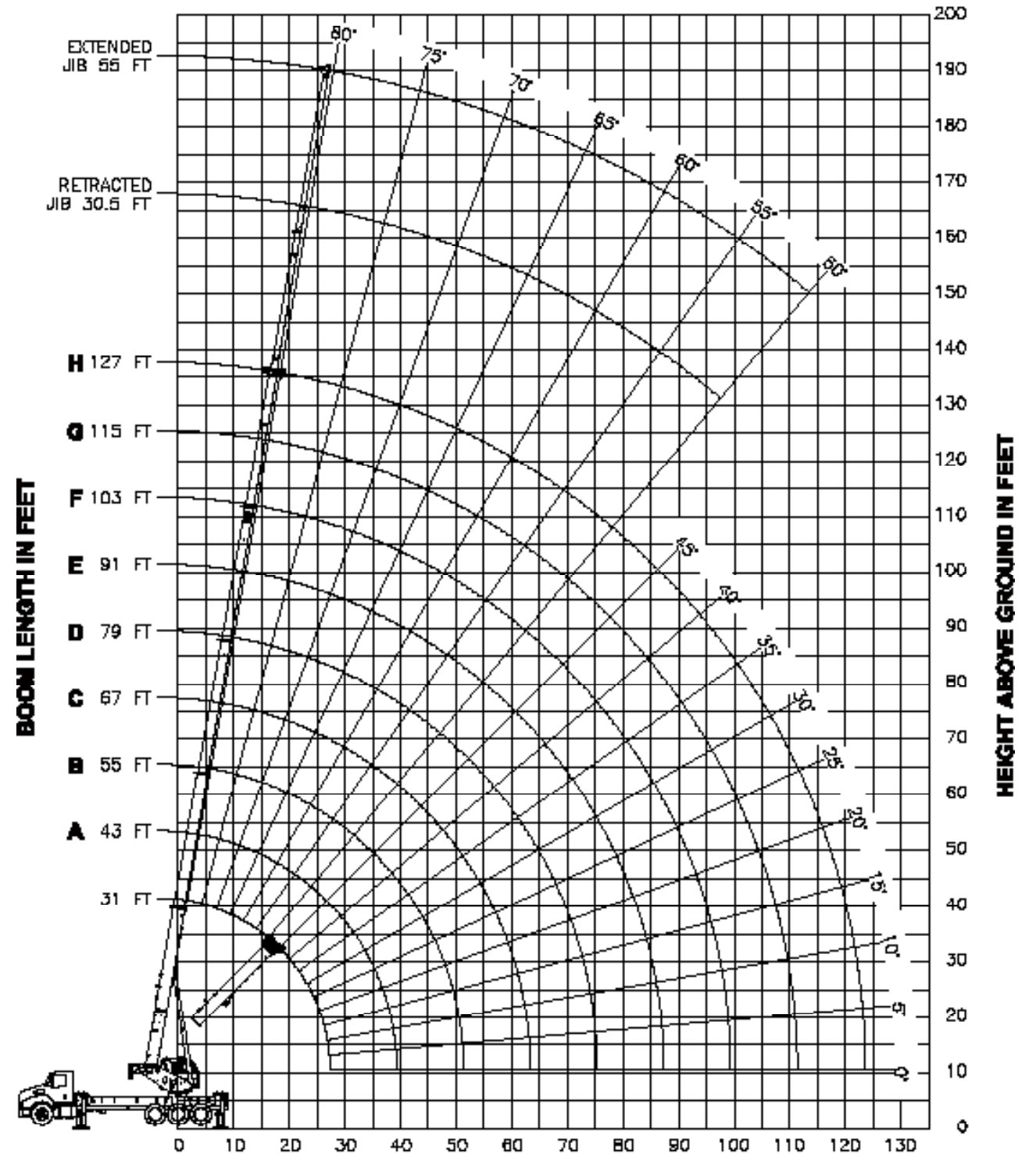

Data published herein is intended as a guide only. Crane operation is subject to machine specific load charts and information.

TC40127 LOAD CHART: Main Boom & Jib

Lifting Capacities 5 section Boom 142 ft. 43,3 m
Full Outrigger Extension



MAIN BOOM RATED LOADS LMI CODES 3																			
Load radius ⊙ °	31 ft.		43 ft. (A)		55 ft. (B)		67 ft. (C)		79 ft. (D)		91 ft. (E)		103 ft. (F)		115 ft. (G)		127 ft. (H)		Load radius ⊙ °
	(deg)	Load Capacity (lbs.)	(deg)	Load Capacity (lbs.)	(deg)	Load Capacity (lbs.)	(deg)	Load Capacity (lbs.)	(deg)	Load Capacity (lbs.)	(deg)	Load Capacity (lbs.)	(deg)	Load Capacity (lbs.)	(deg)	Load Capacity (lbs.)	(deg)	Load Capacity (lbs.)	
7	70	80,000																	7
8	68	80,000																	8
10	64	71,920	72	42,000	76	42,000													10
12	60	60,600	69	42,000	74	42,000													12
15	54	47,660	65	42,000	70	42,000	74	37,500	77	27,900									15
20	41	34,390	57	35,030	65	35,360	70	33,000	73	25,180	75	19,500	77	17,000	78	17,000			20
25	23	26,200	49	26,930	59	27,270	65	27,460	69	22,810	72	17,650	74	15,570	76	13,500	77	10,000	25
30			39	21,450	53	21,800	60	22,000	65	20,940	68	16,250	71	14,420	73	12,420	75	10,000	30
35			26	17,470	46	17,860	55	18,070	61	17,060	65	15,030	68	13,300	70	11,420	72	9,800	35
40					38	14,880	50	15,100	57	15,230	61	13,780	65	12,120	68	10,540	70	9,300	40
45					28	12,330	44	12,630	52	12,810	58	10,990	62	11,050	65	9,550	68	8,800	45
50					13	9,930	37	10,270	47	10,450	54	10,200	59	8,870	62	8,870	65	8,300	50
55							29	8,450	42	8,640	50	8,760	55	8,260	59	8,260	63	7,800	55
60							18	7,000	37	7,200	46	7,330	52	7,410	57	7,480	60	7,450	60
65									30	6,020	41	6,160	48	6,250	53	6,310	57	6,360	65
70									21	4,940	36	5,100	44	5,200	50	5,270	55	5,330	70
75									5	4,010	30	4,210	40	4,320	47	4,390	52	4,450	75
80											23	3,460	36	3,570	43	3,650	49	3,700	80
85											13	2,810	31	2,940	40	3,010	46	3,070	85
90													25	2,300	36	2,340	43	2,480	90
95													17	1,830	31	1,880	39	2,000	95
100															26	1,560	35	1,620	100
105															19	1,180	31	1,240	105
110															9	830	27	910	110
115																	21		115
120																			120
	840 lbs.		610 lbs.		480 lbs.		400 lbs.		340 lbs.		300 lbs.		260 lbs.		240 lbs.		220 lbs.		

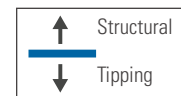

- NOTES:**
- Loads based on crane on outriggers
 - All "on outriggers" loads are based on 85% tipping
 - Loads above heavy line are based on structural rating
 - Loads below heavy line are based on tipping rating

JIB LOAD CAPACITIES					
Load radius ⊙ °	LMI CODE 7		LMI CODE 13		Load radius ⊙ °
	30.5 ft. Tele Jib (deg)	Load Capacity (lbs.)	55 ft. Tele. Jib (deg)	Load Capacity (lbs.)	
15					15
20	79.0	3,450			20
25	77.1	3,400			25
30	75.3	3,320	78.9	2,500	30
35	73.4	3,190	77.3	2,500	35
40	71.5	2,910	75.7	2,500	40
45	69.5	2,770	74.1	2,200	45

50	67.6	2,570	72.4	2,010	50
55	65.6	2,420	70.8	1,870	55
60	63.6	2,270	69.1	1,780	60
65	61.6	2,130	67.4	1,680	65
70	59.5	2,010	65.7	1,570	70
75	57.3	1,910	64.0	1,500	75
80	55.2	1,630	62.2	1,430	80
85	52.9	1,230	60.4	1,350	85
90			58.6	1,250	90
95					95

Data published herein is intended as a guide only. Crane operation is subject to machine specific load charts and information.

TC40127 BOOM DIAGRAM

RANGE DIAGRAM - FULLY EXTENDED OUTRIGGER CONFIGURATION -

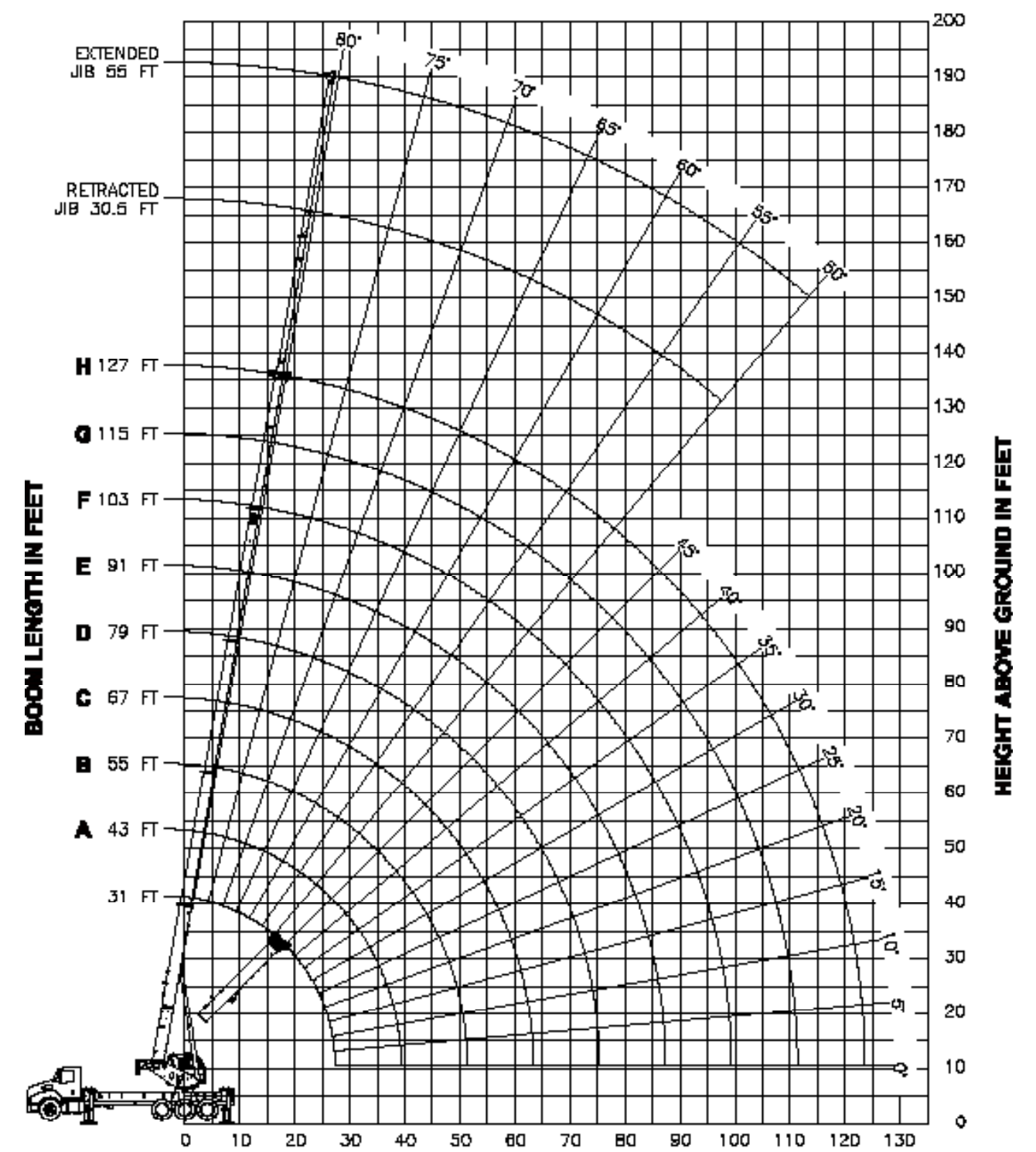

Data published herein is intended as a guide only. Crane operation is subject to machine specific load charts and information.

AREA OF OPERATION

The full length subframe is shown.
The short subframe configuration requires a front bumper stabilizer.

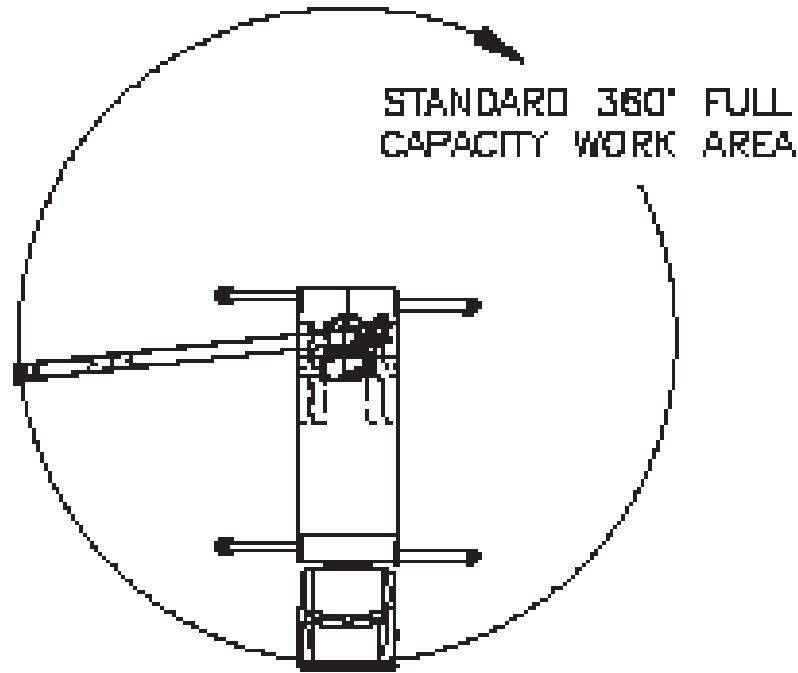

LMI OPERATING CODES

Code	Crane Configuration	Outrigger Configuration
#3	Main Boom	Fully Extended
#7	Telescopic Jib-Retracted	Fully Extended
#13	Telescopic Jib-Extended	Fully Extended
#25	Personnel Lifting Platform on Main Boom	Fully Extended
#26	Personnel Lifting Platform on Telescopic Jib-Retracted	Fully Extended
#29	Personnel Lifting Platform on Telescopic Jib-Extended	Fully Extended
#4	Main Boom	Intermediate

Warning

1. The operator must read and understand the owner's manual before operating the crane.
2. Positioning or operation of crane beyond areas shown on these charts is not intended or approved except where specified in owner's manual.
3. Loaded boom angles at specified boom lengths give only an approximation of the operating radius. The boom angle before loading should be greater to account for deflections. Do not exceed the operating radius for rated loads.
4. The operating radius shown in the jib rating chart is for fully extended boom only. When boom is not fully extended, use only loaded boom angle to determine load rating of jib.
5. For boom angles not shown on jib load rating chart, use rating of next lower boom angle.
6. For boom lengths not shown, use rating of next shorter or longer boom length, whichever is less. For radii not shown, use rating of next longer radius.
7. Crane load ratings on outriggers are based on freely suspended loads with the machine leveled and standing on a firm uniform supporting surface. No attempt shall be made to move a load horizontally on the ground in any direction.
8. Practical working loads depend on supporting surface, wind, and other factors affecting stability such as hazardous surroundings, experience of personnel, and proper handling, all of which must be taken into account by the operator.
9. The maximum load which may be telescoped is limited by hydraulic pressure, boom angle, and boom lubrication. It is safe to attempt to telescope any load within the limits of the load rating chart. Boom must be fully retracted against boom stops at all times when lifting minimum boom length capacity loads.
10. Lifting off the main boom point while the swing around jib is erected is not intended or approved.

Information

1. Deductions must be made from rated loads for stowed jib, optional attachments, hooks, and load blocks (See deduction chart on page 8). Weights of slings and all other load handling devices shall be considered a part of the load.
2. Load ratings above the blue line are structurally limited capacities. Load ratings below the blue line are stability limited capacities and do not exceed 85% of tipping.

Definitions

1. Operating radius is the horizontal distance from the axis of rotation to the center of the vertical hoist line or tackle with load applied.
2. Loaded boom angle as shown in the column head by \angle is the included angle between the horizontal and longitudinal axes of the boom base after lifting rated load at rated radius.



TECHNICAL DESCRIPTIONS

Boom



Boom lengths: Proportional boom

- 5-section 142 ft.
- 4-section 127 ft.
- 4-Sheave Load Quick Reeve boom point
- 2-Sheave Idler boom point

Self lubricating slider pads



Maximum Tip Height

- TC45142 152 ft. (46,3 m)
- TC40142 152 ft. (46,3 m)
- TC45127 137 ft. (41,8 m)
- TC40127 137 ft. (41,8 m)



Boom angle (min/max): -6° / 80°

Rotation



Ball-bearing swing circle with external gear
Double-reduction planetary gearbox driven by hydraulic motor



Slewing brake: Spring-applied pressure released automatic brake
Free Swing and Non-Free Swing selection from the operator's keypad.



Slewing speed: 1.5 - 2 rpm. (nominal)
Boom rotation: 360° continuous

Outriggers



Outriggers: Out-and-down style
FBS - Front Bumper Stabilizer (optional)
Outrigger monitoring system (for verification only)
Outrigger motion alarm

Full extension

- Center to center: 24' 3" (7,3 m)

Mid extension

- Center to center: 17' 6" (5,3 m)

Operator aids



TC400-TC450 is externally routed A2B cable LMI with crane function cut-offs for overload protection. Color graphic display and HDRI-Hoist Drum Rotation Indicator. Crane is shipped remote ready.

Hoist, Rope and Hook



Maximum theoretical line speed: 450 fpm (91 mpm)

Hoist, Rope and Hook Cont.



Maximum theoretical bottom-layer line pull:
11,500 lb (5,216 kg)



Main winch cable diameter: 9/16" (14,3 mm).
6 x 25 EIPS IWRC Wire Rope



Line length: 500 ft. (152,4 m)



Main winch: Bent axis 2-speed hydraulic motor (activated electrically)
Third Wrap Limiter on both Main and Auxiliary Winch.

Overhaul ball: 7T (6,4 mt) capacity hook with heavy-duty swivel and weight is provided for single line operation.

Hydraulics



8-bolt direct mounted PTO and SAE C output (factory mounted units only)
1-Section Variable Displacement Piston Pump, SAE C input.
Piggy back Fixed Gear Pump
Hydraulic Reservoir Capacity: 155 Gallon
Pump Sections @ 2000 RPM with 100 PSI

- Variable Displacement Pump: 77 GPM (291 lpm)
- Fixed Displacement Gear Pump: 12 GPM (45 lpm)

Tiltable Cab/Cab Controls



Standard features:
Curved glass, 0° to 20° cab tilt, Sliding door, heated cloth seat, 8 seat adjustments, lumbar support, reclining and adjustable head rest, sliding windows, rear pop out window, top hinged hatch, with guard, front and top windshield wiper, heater, air conditioning, 12 volt DC outlet, USB ports, engine monitoring system, E-coated cab (10 year rust warranty)



Controls:
PLC crane controller, CANBUS communication, J1939 truck engine communication, electric hand and foot throttle, twin dual axis joysticks, electric/hydraulic valve actuation, electronic sensor monitoring, Hirschmann/PAT or 3B6 LMI system available, wired ATB and wired wind speed sensors, telematics, GPS monitoring, remote diagnostic capability, Work Area Definition (WADs)

OPTIONS

Boom

Jibs

TC400-TC450

- 2-Section telescoping jib 31' (9,4 m) to 55' (16,8 m)

Maximum Tip Height with Extension



TC40127 - TC45127

- Maximum tip height with extension: 190 ft. (57,9 m)
- Maximum tip height with extension retracted: 165 ft. (50, 3 m)

TC40142 - TC45142

- Maximum tip height with extension: 205 ft. (62,5 m)
- Maximum tip height with extension retracted: 180 ft. (54,9 m)

Tool Boxes

Tool Boxes

- 24 in. L x 18 in. W x 18 in. H (610 mm L x 457 mm W x 457 mm H)
- 48 in. L x 24 in. W x 24 in. H (1,219 mm L x 610 mm W x 610 mm H)

Auxiliary Winch



Auxiliary Winch: Bent axis 2-speed hydraulic motor (activated electrically)
Third Wrap Limiter on winch

Hydraulics



Optional Front Bumper Stabilizer
Optional Hydraulic Tank Heater

Cab



Video camera (1 or 2)
Cab weather band radio system

2-person Basket



Consult Manitex for specific application and rating

- 2-person Steel Gravity Levelled Basket with Friction Brake
- 2-person Aluminum or Steel Quick-Attached Rotating Basket

Operator aids



4-function radio remote crane control system with joy sticks

- 900 Mhz
- 400 Mhz

A92.2 Aerial Lift Manbasket Dual Rating
Wired Wind Speed Sensor

Hoist and Hook



Auxiliary lower sheave block for 2-8 part lines
Load blocks 1-3, 1-6, 2-6 part lines

Aerial Device A92.2 Option

A92.2 Aerial Lift Manbasket Dual Rating

Manitex



TC450

45-Ton (40.8 mt) TELESCOPIC CRANE
TC450 SERIES PRODUCT GUIDE

UPTIME

UPTIME is the Manitex commitment to complete support of thousands of units working every day.

MANITEX

3000 South Austin Avenue
Georgetown, Texas 78626

1-877-314-3390 | www.Manitex.com

MTX-TC400-TC450-PC-EN-V1-0217